

*Indian Standard*

CODE OF PRACTICE FOR DESIGN LOADS  
( OTHER THAN EARTHQUAKE )  
FOR BUILDINGS AND STRUCTURES

PART 3 WIND LOADS

( Second Revision )

Sixth Reprint NOVEMBER 1998

UDC 624·042·41

© Copyright 1989

**BUREAU OF INDIAN STANDARDS**  
MANAK BHAVAN, 9 BAHADUR SHAH ZAFAR MARG  
NEW DELHI 110002

## CONTENTS

	<i>Page</i>
0. FOREWORD	3
1. SCOPE	5
2. NOTATIONS	5
3. TERMINOLOGY	6
4. GENERAL	7
5. WIND SPEED AND PRESSURE	7
5.1 Nature of Wind in Atmosphere	7
5.2 Basic Wind Speed	8
5.3 Design Wind Speed ( $V_z$ )	8
5.3.1 Risk Coefficient ( $k_1$ Factor )	8
5.3.2 Terrain, Height and Structure Size Factor ( $k_2$ Factor )	8
5.3.3 Topography ( $k_3$ Factor )	12
5.4 Design Wind Pressure	12
5.5 Off-Shore Wind Velocity	13
6. WIND PRESSURES AND FORCES ON BUILDINGS/STRUCTURES	13
6.1 General	13
6.2 Pressure Coefficients	13
6.2.1 Wind Load on Individual Members	13
6.2.2 External Pressure Coefficients	13
6.2.3 Internal Pressure Coefficients	27
6.3 Force Coefficients	36
6.3.1 Frictional Drag	37
6.3.2 Force Coefficients for Clad Buildings	37
6.3.3 Force Coefficients for Unclad Buildings	38
7. DYNAMIC EFFECTS	47
7.1 General	47
7.2 Motion Due to Vortex Shedding	48
7.2.1 Slender Structures	48
8. Gust Factor ( $GF$ ) or Gust Effectiveness Factor ( $GEF$ ) Method	49
8.1 Application	49
8.2 Hourly Mean Wind	49
8.2.1 Variation of Hourly Mean Wind Speed with Height	49
8.3 Along Wind Load	49
APPENDIX A BASIC WIND SPEED AT 10 m HEIGHT FOR SOME IMPORTANT CITIES/TOWNS	53
APPENDIX B CHANGES IN TERRAIN CATEGORIES	54
APPENDIX C EFFECT OF A CLIFF OR ESCARPMENT ON EQUIVALENT HEIGHT ABOVE GROUND ( $k_3$ FACTOR )	55
APPENDIX D WIND FORCE ON CIRCULAR SECTIONS	57

As in the Original Standard, this Page is Intentionally Left Blank

*Indian Standard*

# CODE OF PRACTICE FOR DESIGN LOADS ( OTHER THAN EARTHQUAKE ) FOR BUILDINGS AND STRUCTURES

**PART 3 WIND LOADS***( Second Revision )***0. FOREWORD**

**0.1** This Indian Standard ( Part 3 ) ( Second Revision ) was adopted by the Bureau of Indian Standards on 13 November 1987, after the draft finalized by the Structural Safety Sectional Committee had been approved by the Civil Engineering Division Council.

**0.2** A building has to perform many functions satisfactorily. Amongst these functions are the utility of the building for the intended use and occupancy, structural safety, fire safety and compliance with hygienic, sanitation, ventilation and daylight standards. The design of the building is dependent upon the minimum requirements prescribed for each of the above functions. The minimum requirements pertaining to the structural safety of buildings are being covered in loading codes by way of laying down minimum design loads which have to be assumed for dead loads, imposed loads, wind loads and other external loads, the structure would be required to bear. Strict conformity to loading standards, it is hoped, will not only ensure the structural safety of the buildings and structures which are being designed and constructed in the country and thereby reduce the hazards to life and property caused by unsafe structures, but also eliminate the wastage caused by assuming unnecessarily heavy loadings without proper assessment.

**0.3** This standard was first published in 1957 for the guidance of civil engineers, designers and architects associated with the planning and design of buildings. It included the provisions for the basic design loads ( dead loads, live loads, wind loads and seismic loads ) to be assumed in the design of the buildings. In its first revision in 1964, the wind pressure provisions were modified on the basis of studies of wind phenomenon and its effect on structures, undertaken by the special committee in consultation with the Indian Meteorological Department. In addition to this, new clauses on wind loads for butterfly type structures were included; wind pressure coefficients for

sheeted roofs, both curved and sloping were modified; seismic load provisions were deleted ( separate code having been prepared ) and metric system of weights and measurements was adopted.

**0.3.1** With the increased adoption of this Code, a number of comments were received on provisions on live load values adopted for different occupancies. Simultaneously, live load surveys have been carried out in America and Canada to arrive at realistic live loads based on actual determination of loading ( movable and immovable ) in different occupancies. Keeping this in view and other developments in the field of wind engineering, the Structural Safety Sectional Committee decided to prepare the second revision of IS : 875 in the following five parts:

Part 1 Dead loads

Part 2 Imposed loads

Part 3 Wind loads

Part 4 Snow loads

Part 5 Special loads and load combinations

Earthquake load is covered in a separate standard, namely, IS : 1893-1984\* which should be considered along with the above loads.

**0.3.2** This Part ( Part 3 ) deals with wind loads to be considered when designing buildings, structures and components thereof. In this revision, the following important modifications have been made from those covered in the 1964 version of IS : 875:

- a) The earlier wind pressure maps ( one giving winds of shorter duration and another excluding winds of shorter duration )

\*Criteria for earthquake resistant design of structures ( fourth revision ).

have been replaced by a single wind map giving basic maximum wind speed in m/s ( peak gust velocity averaged over a short time interval of about 3 seconds duration ). The wind speeds have been worked out for 50 years return period based on the up-to-date wind data of 43 dines pressure tube ( DPT ) anemograph stations and study of other related works available on the subject since 1964. The map and related recommendations have been provided in the code with the active cooperation of Indian Meteorological Department ( IMD ). Isotachs ( lines of equal velocity ) have not been given as in the opinion of the committee, there is still not enough extensive meteorological data at close enough stations in the country to justify drawing of isotachs.

- b) Modification factors to modify the basic wind velocity to take into account the effects of terrain, local topography, size of structure, etc, are included.
- c) Terrain is now classified into four categories based on characteristics of the ground surface irregularities.
- d) Force and pressure coefficients have been included for a large range of clad and unclad buildings and for individual structural elements.
- e) Force coefficients ( drag coefficients ) are given for frames, lattice towers, walls and hoardings.
- f) The calculation of force on circular sections is included incorporating the effects of Reynolds number and surface roughness.
- g) The external and internal pressure coefficients for gable roofs, lean-to roofs, curved roofs, canopy roofs ( butterfly type structures ) and multi-span roofs have been rationalised.
- h) Pressure coefficients are given for combined roofs, roofs with sky light, circular silos, cylindrical elevated structures, grandstands, etc.
- j) Some requirements regarding study of dynamic effects in flexible slender structures are included.
- k) Use of gust energy method to arrive at the design wind load on the whole structure is now permitted.

**0.3.3** The Committee responsible for the revision of wind maps while reviewing available

meteorological wind data and response of structures to wind, felt the paucity of data on which to base wind maps for Indian conditions on statistical analysis. The Committee, therefore, recommends to all individuals and organizations responsible for putting-up of tall structures to provide instrumentation in their existing and new structures ( transmission towers, chimneys, cooling towers, buildings, etc ) at different elevations ( at least at two levels ) to continuously measure and monitor wind data. The instruments are required to collect data on wind direction, wind speed and structural response of the structure due to wind ( with the help of accelerometer, strain gauges, etc ). It is also the opinion of the committee that such instrumentation in tall structures will not in any way affect or alter the functional behaviour of such structures. The data so collected will be very valuable in evolving more accurate wind loading of structures.

**0.4** The Sectional Committee responsible for the preparation of this standard has taken into account the prevailing practice in regard to loading standards followed in this country by the various authorities and has also taken note of the developments in a number of other countries. In the preparation of this code, the following overseas standards have also been examined:

- a) BSCP 3 : 1973 Code of basic data for design of buildings: Chapter V Loading, Part 2 Wind loads.
- b) AS 1170, Part 2-1983 SAA Loading code Part 2 — Wind forces.
- c) NZS 4203-1976 Code of practice for general structural design loading for buildings.
- d) ANSI A58.1-1972 American Standard Building code requirements for minimum design loads in buildings and other structures.
- e) Wind resistant design regulations, A World List. Association for Science Documents Information, Tokyo.

**0.5** For the purpose of deciding whether a particular requirement of this standard is complied with, the final value, observed or calculated, expressing the result of a test or analysis, shall be rounded off in accordance with IS : 2-1960\*. The number of significant places retained in the rounded off value should be the same as that of the specified value in this standard.

---

\*Rules for rounding off numerical values ( revised ).

## 1. SCOPE

**1.1** This standard gives wind forces and their effects (static and dynamic) that should be taken into account when designing buildings, structures and components thereof.

**1.1.1** It is believed that ultimately wind load estimation will be made by taking into account the random variation of wind speed with time but available theoretical methods have not matured sufficiently at present for use in the code. For this reason, static wind method of load estimation which implies a steady wind speed, which has proved to be satisfactory for normal, short and heavy structures, is given in 5 and 6. However, a beginning has been made to take account of the random nature of the wind speed by requiring that the along-wind or drag load on structures which are prone to wind induced oscillations, be also determined by the gust factor method (see 8) and the more severe of the two estimates be taken for design.

A large majority of structures met with in practice do not however, suffer wind induced oscillations and generally do not require to be examined for the dynamic effects of wind, including use of gust factor method. Nevertheless, there are various types of structures or their components such as some tall buildings, chimneys, latticed towers, cooling towers, transmission towers, guyed masts, communication towers, long span bridges, partially or completely solid faced antenna dish, etc, which require investigation of wind induced oscillations. The use of 7 shall be made for identifying and analysing such structures.

**1.1.2** This code also applies to buildings or other structures during erection/construction and the same shall be considered carefully during various stages of erection/construction. In locations where the strongest winds and icing may occur simultaneously, loads on structural members, cables and ropes shall be calculated by assuming an ice covering based on climatic and local experience.

**1.1.3** In the design of special structures, such as chimneys, overhead transmission line towers, etc, specific requirements as specified in the respective codes shall be adopted in conjunction with the provisions of this code as far as they are applicable. Some of the Indian Standards available for the design of special structures are:

IS : 4998 ( Part 1 )-1975 Criteria for design of reinforced concrete chimneys: Part 1 Design criteria ( *first revision* )

IS : 6533-1971 Code of practice for design and construction of steel chimneys

IS : 5613 ( Part 1/Sec 1 )-1970 Code of practice for design, installation and maintenance of overhead power lines: Part 1 Lines up to and including 11 kV, Section 1 Design

IS : 802 ( Part 1 )-1977 Code of practice for use of structural steel in overhead transmission line towers: Part 1 Loads and permissible stresses ( *second revision* )

IS : 11504-1985 Criteria for structural design of reinforced concrete natural draught cooling towers

**NOTE 1** — This standard does not apply to buildings or structures with unconventional shapes, unusual locations, and abnormal environmental conditions that have not been covered in this code. Special investigations are necessary in such cases to establish wind loads and their effects. Wind tunnel studies may also be required in such situations.

**NOTE 2** — In the case of tall structures with unsymmetrical geometry, the designs may have to be checked for torsional effects due to wind pressure.

## 2. NOTATIONS

**2.1** The following notations shall be followed unless otherwise specified in relevant clauses:

- $A$  = surface area of a structure or part of a structure;
- $A_e$  = effective frontal area;
- $A_z$  = an area at height  $z$ ;
- $b$  = breadth of a structure or structural member normal to the wind stream in the horizontal plane;
- $C_f$  = force coefficient/drag coefficient;
- $C_{fn}$  = normal force coefficient;
- $C_{ft}$  = transverse force coefficient;
- $C'_f$  = frictional drag coefficient;
- $C_p$  = pressure coefficient;
- $C_{pe}$  = external pressure coefficient;
- $C_{pi}$  = internal pressure coefficient;
- $d$  = depth of a structure or structural member parallel to wind stream;
- $D$  = diameter of cylinder;
- $F$  = force normal to the surface;
- $F_n$  = normal force;
- $F_t$  = transverse force;
- $F'$  = frictional force;
- $h$  = height of structure above mean ground level;
- $h_x$  = height of development of a velocity profile at a distance  $x$  down wind from a change in terrain category;
- $\left. \begin{matrix} k_1 \\ k_2 \\ k_3 \end{matrix} \right\}$  = multiplication factors;
- $K$  = multiplication factor;
- $l$  = length of the member or greater horizontal dimension of a building;
- $p_d$  = design wind pressure;

- $p_z$  = design wind pressure at height  $z$ ;  
 $p_e$  = external pressure;  
 $p_i$  = internal pressure;  
 $R_e$  = reynolds number;  
 $S$  = strouhal number;  
 $V_b$  = regional basic wind speed;  
 $V_z$  = design wind velocity at height  $z$ ;  
 $\bar{V}_z$  = hourly mean wind speed at height  $z$ ;  
 $w$  = lesser horizontal dimension of a building, or a structural member;  
 $w'$  = bay width in multi-bay buildings;  
 $x$  = distance down wind from a change in terrain category;  
 $\theta$  = wind angle from a given axis;  
 $\alpha$  = inclination of the roof to the horizontal;  
 $\beta$  = effective solidity ratio;  
 $\eta$  = shielding factor or shedding frequency;  
 $\phi$  = solidity ratio;  
 $z$  = a height or distance above the ground; and  
 $\epsilon$  = average height of the surface roughness.

### 3. TERMINOLOGY

3.1 For the purpose of this code, the following definitions shall apply.

3.1.1 *Angle of Attack* — Angle between the direction of wind and a reference axis of the structure.

3.1.2 *Breadth* — Breadth means horizontal dimension of the building measured normal to the direction of wind.

NOTE — Breadth and depth are dimensions measured in relation to the direction of the wind, whereas length and width are dimensions related to the plan.

3.1.3 *Depth* — Depth means the horizontal dimension of the building measured in the direction of the wind.

3.1.4 *Developed Height* — Developed height is the height of upward penetration of the velocity profile in a new terrain. At large fetch lengths, such penetration reaches the gradient height, above which the wind speed may be taken to be constant. At lesser fetch lengths, a velocity profile of a smaller height but similar to that of the fully developed profile of that terrain category has to be taken, with the additional provision that the velocity at the top of this shorter profile equals that of the unpenetrated earlier velocity profile at that height.

3.1.5 *Effective Frontal Area* — The projected area of the structure normal to the direction of the wind.

3.1.6 *Element of Surface Area* — The area of surface over which the pressure coefficient is taken to be constant.

3.1.7 *Force Coefficient* — A non-dimensional coefficient such that the total wind force on a body is the product of the force coefficient, the dynamic pressure of the incident design wind speed and the reference area over which the force is required.

NOTE — When the force is in the direction of the incident wind, the non-dimensional coefficient will be called as 'drag coefficient'. When the force is perpendicular to the direction of incident wind, the non-dimensional coefficient will be called as 'lift coefficient'.

3.1.8 *Ground Roughness* — The nature of the earth's surface as influenced by small scale obstructions such as trees and buildings ( as distinct from topography ) is called ground roughness.

3.1.9 *Gust* — A positive or negative departure of wind speed from its mean value, lasting for not more than, say, 2 minutes over a specified interval of time.

*Peak Gust* — Peak gust or peak gust speed is the wind speed associated with the maximum amplitude.

*Fetch Length* — Fetch length is the distance measured along the wind from a boundary at which a change in the type of terrain occurs. When the changes in terrain types are encountered ( such as, the boundary of a town or city, forest, etc ), the wind profile changes in character but such changes are gradual and start at ground level, spreading or penetrating upwards with increasing fetch length.

*Gradient Height* — Gradient height is the height above the mean ground level at which the gradient wind blows as a result of balance among pressure gradient force, coriolis force and centrifugal force. For the purpose of this code, the gradient height is taken as the height above the mean ground level, above which the variation of wind speed with height need not be considered.

*Mean Ground Level* — The mean ground level is the average horizontal plane of the area enclosed by the boundaries of the structure.

*Pressure Coefficient* — Pressure coefficient is the ratio of the difference between the pressure acting at a point on a surface and the static pressure of the incident wind to the design wind pressure, where the static and design wind pressures are determined at the height of the point considered after taking into account the geographical location, terrain conditions and shielding effect. The pressure coefficient is also equal to  $[1 - (V_p/V_z)^2]$ , where  $V_p$  is the actual wind speed at any point

on the structure at a height corresponding to that of  $V_z$ .

**NOTE** — Positive sign of the pressure coefficient indicates pressure acting towards the surface and negative sign indicates pressure acting away from the surface.

**Return Period** — Return period is the number of years, the reciprocal of which gives the probability of extreme wind exceeding a given wind speed in any one year.

**Shielding Effect** — Shielding effect or shielding refers to the condition where wind has to pass along some structure(s) or structural element(s) located on the upstream wind side, before meeting the structure or structural element under consideration. A factor called 'shielding factor' is used to account for such effects in estimating the force on the shielded structures.

**Suction** — Suction means pressure less than the atmospheric ( static ) pressure and is taken to act away from the surface.

**Solidity Ratio** — Solidity ratio is equal to the effective area ( projected area of all the individual elements ) of a frame normal to the wind direction divided by the area enclosed by the boundary of the frame normal to the wind direction.

**NOTE** — Solidity ratio is to be calculated for individual frames.

**Terrain Category** — Terrain category means the characteristics of the surface irregularities of an area which arise from natural or constructed features. The categories are numbered in increasing order of roughness.

**Velocity Profile** — The variation of the horizontal component of the atmospheric wind speed at different heights above the mean ground level is termed as velocity profile.

**Topography** — The nature of the earth's surface as influenced the hill and valley configurations.

#### 4. GENERAL

**4.1** Wind is air in motion relative to the surface of the earth. The primary cause of wind is traced to earth's rotation and differences in terrestrial radiation. The radiation effects are primarily responsible for convection either upwards or downwards. The wind generally blows horizontal to the ground at high wind speeds. Since vertical components of atmospheric motion are relatively small, the term 'wind' denotes almost exclusively the horizontal wind, vertical winds are always identified as such. The wind speeds are assessed with the aid of anemometers or anemographs which are installed at meteorological observatories at heights generally varying from 10 to 30 metres above ground.

**4.2** Very strong winds ( greater than 80 km/h ) are generally associated with cyclonic storms,

thunderstorms, dust storms or vigorous monsoons. A feature of the cyclonic storms over the Indian area is that they rapidly weaken after crossing the coasts and move as depressions/lows inland. The influence of a severe storm after striking the coast does not, in general exceed about 60 kilometres, though sometimes, it may extend even up to 120 kilometres. Very short duration hurricanes of very high wind speeds called Kal Baisaki or Norwesters occur fairly frequently during summer months over North East India.

**4.3** The wind speeds recorded at any locality are extremely variable and in addition to steady wind at any time, there are effects of gusts which may last for a few seconds. These gusts cause increase in air pressure but their effect on stability of the building may not be so important; often, gusts affect only part of the building and the increased local pressures may be more than balanced by a momentary reduction in the pressure elsewhere. Because of the inertia of the building, short period gusts may not cause any appreciable increase in stress in main components of the building although the walls, roof sheeting and individual cladding units ( glass panels ) and their supporting members such as purlins, sheeting rails and glazing bars may be more seriously affected. Gusts can also be extremely important for design of structures with high slenderness ratios.

**4.4** The liability of a building to high wind pressures depends not only upon the geographical location and proximity of other obstructions to air flow but also upon the characteristics of the structure itself.

**4.5** The effect of wind on the structure as a whole is determined by the combined action of external and internal pressures acting upon it. In all cases, the calculated wind loads act normal to the surface to which they apply.

**4.6** The stability calculations as a whole shall be done considering the combined effect, as well as separate effects of imposed loads and wind loads on vertical surfaces, roofs and other part of the building above general roof level.

**4.7** Buildings shall also be designed with due attention to the effects of wind on the comfort of people inside and outside the buildings.

#### 5. WIND SPEED AND PRESSURE

**5.1 Nature of Wind in Atmosphere** — In general, wind speed in the atmospheric boundary layer increases with height from zero at ground level to a maximum at a height called the gradient height. There is usually a slight change in direction ( Ekman effect ) but this is ignored in the code. The variation with height depends primarily on the terrain conditions. However, the wind speed at any height never remains constant and it has been found convenient to resolve its instantaneous magnitude into an average or mean value and a fluctuating component around this



average value. The average value depends on the averaging time employed in analysing the meteorological data and this averaging time varies from a few seconds to several minutes. The magnitude of fluctuating component of the wind speed which is called gust, depends on the averaging time. In general, smaller the averaging interval, greater is the magnitude of the gust speed.

**5.2 Basic Wind Speed** — Figure 1 gives basic wind speed map of India, as applicable to 10 m height above mean ground level for different zones of the country. Basic wind speed is based on peak gust velocity averaged over a short time interval of about 3 seconds and corresponds to mean heights above ground level in an open terrain ( Category 2 ). Basic wind speeds presented in Fig. 1 have been worked out for a 50 year return period. Basic wind speed for some important cities/towns is also given in Appendix A.

**5.3 Design Wind Speed ( $V_z$ )** — The basic wind speed ( $V_b$ ) for any site shall be obtained from Fig. 1 and shall be modified to include the following effects to get design wind velocity at any height ( $V_z$ ) for the chosen structure:

- a) Risk level;
- b) Terrain roughness, height and size of structure; and
- c) Local topography.

It can be mathematically expressed as follows:

$$V_z = V_b k_1 k_2 k_3$$

where

$V_z$  = design wind speed at any height  $z$  in m/s;

$k_1$  = probability factor ( risk coefficient ) ( see 5.3.1 );

$k_2$  = terrain, height and structure size factor ( see 5.3.2 ); and

$k_3$  = topography factor ( see 5.3.3 ).

NOTE — Design wind speed up to 10 m height from mean ground level shall be considered constant.

**5.3.1 Risk Coefficient ( $k_1$  Factor)** — Figure 1 gives basic wind speeds for terrain Category 2 as applicable at 10 m above ground level based on 50 years mean return period. The suggested life period to be assumed in design and the corresponding  $k_1$  factors for different class of structures for the purpose of design is given in Table 1. In the design of all buildings and structures, a regional basic wind speed having a mean return period of 50 years shall be used except as specified in the note of Table 1.

**5.3.2 Terrain, Height and Structure Size Factor ( $k_2$  Factor)**

**5.3.2.1 Terrain** — Selection of terrain categories shall be made with due regard to the effect

of obstructions which constitute the ground surface roughness. The terrain category used in the design of a structure may vary depending on the direction of wind under consideration. Wherever sufficient meteorological information is available about the nature of wind direction, the orientation of any building or structure may be suitably planned.

Terrain in which a specific structure stands shall be assessed as being one of the following terrain categories:

- a) *Category 1* — Exposed open terrain with few or no obstructions and in which the average height of any object surrounding the structure is less than 1.5 m.

NOTE — This category includes open sea-coasts and flat treeless plains.

- b) *Category 2* — Open terrain with well scattered obstructions having heights generally between 1.5 to 10 m.

NOTE — This is the criterion for measurement of regional basic wind speeds and includes airfields, open parklands and undeveloped sparsely built-up outskirts of towns and suburbs. Open land adjacent to sea coast may also be classified as Category 2 due to roughness of large sea waves at high winds.

- c) *Category 3* — Terrain with numerous closely spaced obstructions having the size of building-structures up to 10 m in height with or without a few isolated tall structures.

NOTE 1 — This category includes well wooded areas, and shrubs, towns and industrial areas full or partially developed.

NOTE 2 — It is likely that the next higher category than this will not exist in most design situations and that selection of a more severe category will be deliberate.

NOTE 3 — Particular attention must be given to performance of obstructions in areas affected by fully developed tropical cyclones. Vegetation which is likely to be blown down or defoliated cannot be relied upon to maintain Category 3 conditions. Where such situation may exist, either an intermediate category with velocity multipliers midway between the values for Category 2 and 3 given in Table 2, or Category 2 should be selected having due regard to local conditions.

- d) *Category 4* — Terrain with numerous large high closely spaced obstructions.

NOTE — This category includes large city centres, generally with obstructions above 25 m and well developed industrial complexes.

**5.3.2.2 Variation of wind speed with height for different sizes of structures in different terrains ( $k_2$  factor)** — Table 2 gives multiplying factors ( $k_2$ ) by which the basic wind speed given in Fig. 1 shall be multiplied to obtain the wind speed at different heights, in each terrain category for different sizes of buildings/structures.

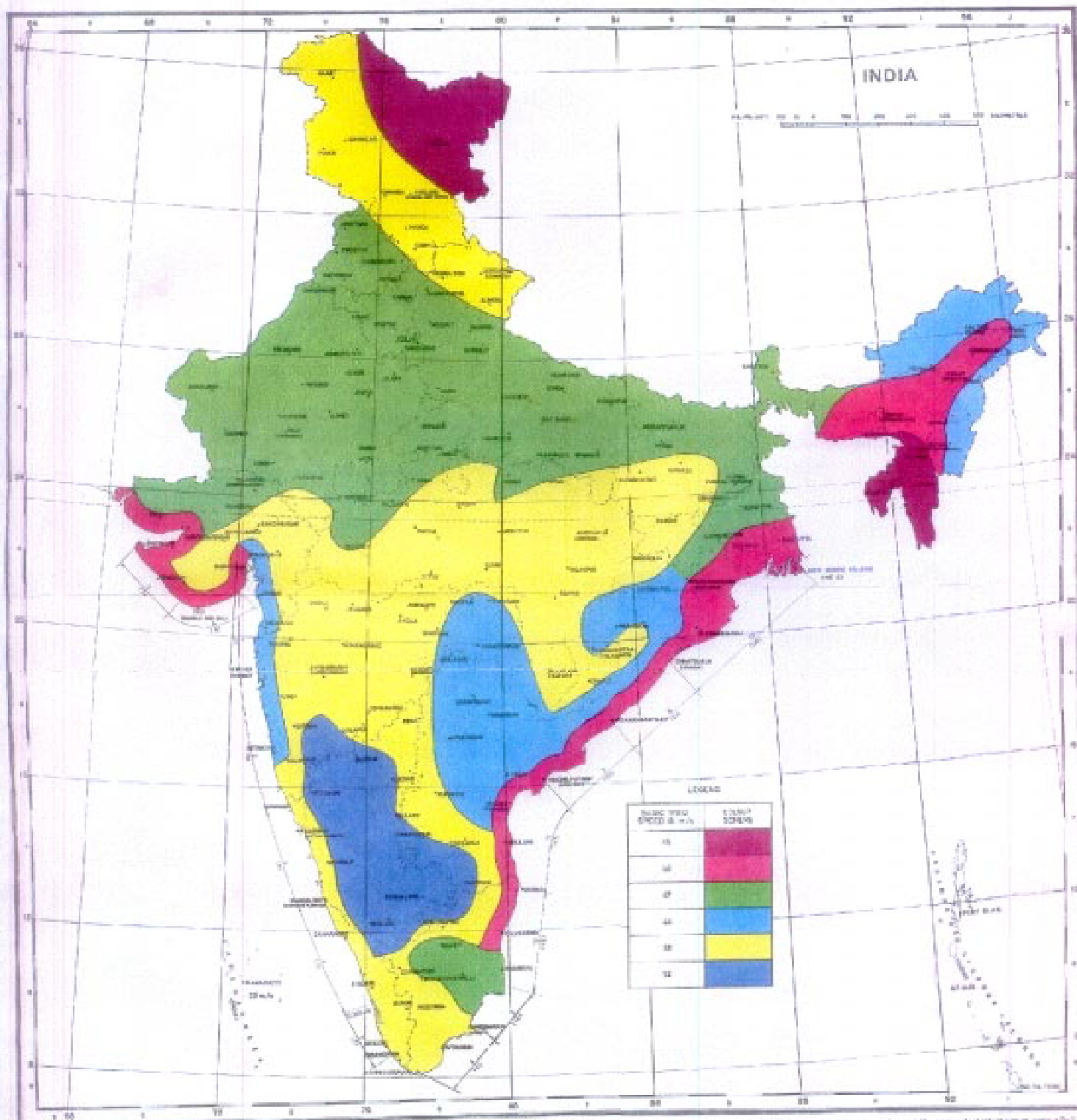

FIG. 1. BARD WIND SPEED (m/s) (BASED ON 50-YEAR RETURN PERIOD)

Approved by the Council of Ministers and the Government of India, New Delhi, India.

The boundaries of the zones may be used for a variety of other purposes where deemed fit by the user.

Responsibility for the accuracy of the data shown on the map rests with the publisher.

The boundary of the zone shown on this map is an approximation based on the information available at the time of publication.

This is a reproduction of the original work published by the Government of India, New Delhi, India. The Government of India, New Delhi, India, is not responsible for any errors or omissions in this work.

This work is published under the terms of the Government of India, New Delhi, India, Copyright Act, 1957. All rights reserved.

As in the Original Standard, this Page is Intentionally Left Blank

The buildings/structures are classified into the following three different classes depending upon their size:

*Class A* — Structures and/or their components such as cladding, glazing, roofing, etc, having maximum dimension ( greatest horizontal or vertical dimension ) less than 20 m.

*Class B* — Structures and/or their com-

ponents such as cladding, glazing, roofing, etc, having maximum dimension\* ( greatest horizontal or vertical dimension ) between 20 and 50 m.

*Class C* — Structures and/or their components such as cladding, glazing, roofing, etc, having maximum dimension ( greatest horizontal or vertical dimension ) greater than 50 m.

**TABLE 1 RISK COEFFICIENTS FOR DIFFERENT CLASSES OF STRUCTURES IN DIFFERENT WIND SPEED ZONES**

( Clause 5.3.1 )

CLASS OF STRUCTURE	MEAN PROBABLE DESIGN LIFE OF STRUCTURE IN YEARS	$k_1$ FACTOR FOR BASIC WIND SPEED (m/s) OF					
		33	39	44	47	50	55
All general buildings and structures	50	1.0	1.0	1.0	1.0	1.0	1.0
Temporary sheds, structures such as those used during construction operations ( for example, formwork and falsework ), structures during construction stages and boundary walls	5	0.82	0.76	0.73	0.71	0.70	0.67
Buildings and structures presenting a low degree of hazard to life and property in the event of failure, such as isolated towers in wooded areas, farm buildings other than residential buildings	25	0.94	0.92	0.91	0.90	0.90	0.89
Important buildings and structures such as hospitals communication buildings / towers, power plant structures	100	1.05	1.06	1.07	1.07	1.08	1.08

NOTE — The factor  $k_1$  is based on statistical concepts which take account of the degree of reliability required and period of time in years during which these will be exposure to wind, that is, life of the structure. Whatever wind speed is adopted for design purposes, there is always a probability ( however small ) that it may be exceeded in a storm of exceptional violence; the greater the period of years over which these will be exposure to the wind, the greater is the probability. Higher return periods ranging from 100 to 1 000 years ( implying lower risk level ) in association with greater periods of exposure may have to be selected for exceptionally important structures, such as, nuclear power reactors and satellite communication towers. Equation given below may be used in such cases to estimate  $k_1$  factors for different periods of exposure and chosen probability of exceedance ( risk level ). The probability level of 0.63 is normally considered sufficient for design of buildings and structures against wind effects and the values of  $k_1$  corresponding to this risk level are given above.

$$k_1 = \frac{X_{N,P}}{X_{50,0.63}} = \frac{A - B \left[ \ln \left\{ -\frac{1}{N} \ln (1 - P_N) \right\} \right]}{A + 4B}$$

where

$N$  = mean probable design life of structure in years;

$P_N$  = risk level in  $N$  consecutive years ( probability that the design wind speed is exceeded at least once in  $N$  successive years ), nominal value = 0.63;

$X_{N,P}$  = extreme wind speed for given values of  $N$  and  $P_N$ ; and

$X_{50,0.63}$  = extreme wind speed for  $N = 50$  years and  $P_N = 0.63$ .

$A$  and  $B$  are coefficients having the following values for different basic wind speed zones:

Zone	A	B
33 m/s	83.2	9.2
39 m/s	84.0	14.0
44 m/s	88.0	18.0
47 m/s	88.0	20.5
50 m/s	88.8	22.8
55 m/s	90.8	27.3

**TABLE 2  $k_z$  FACTORS TO OBTAIN DESIGN WIND SPEED VARIATION WITH HEIGHT IN DIFFERENT TERRAINS FOR DIFFERENT CLASSES OF BUILDINGS/STRUCTURES**

( Clause 5.3.2.2 )

HEIGHT m	TERRAIN CATEGORY 1 CLASS			TERRAIN CATEGORY 2 CLASS			TERRAIN CATEGORY 3 CLASS			TERRAIN CATEGORY 4 CLASS		
	A	B	C	A	B	C	A	B	C	A	B	C
(1)	(2)	(3)	(4)	(5)	(6)	(7)	(8)	(9)	(10)	(11)	(12)	(13)
10	1.05	1.03	0.99	1.00	0.98	0.93	0.91	0.88	0.82	0.80	0.76	0.67
15	1.09	1.07	1.03	1.05	1.02	0.97	0.97	0.94	0.87	0.80	0.76	0.67
20	1.12	1.10	1.06	1.07	1.05	1.00	1.01	0.98	0.91	0.80	0.76	0.67
30	1.15	1.13	1.09	1.12	1.10	1.04	1.06	1.03	0.96	0.97	0.93	0.83
50	1.20	1.18	1.14	1.17	1.15	1.10	1.12	1.09	1.02	1.10	1.05	0.95
100	1.26	1.24	1.20	1.24	1.22	1.17	1.20	1.17	1.10	1.20	1.15	1.05
150	1.30	1.28	1.24	1.28	1.25	1.21	1.24	1.21	1.15	1.24	1.20	1.10
200	1.32	1.30	1.26	1.30	1.28	1.24	1.27	1.24	1.18	1.27	1.22	1.13
250	1.34	1.32	1.28	1.32	1.31	1.26	1.29	1.26	1.20	1.28	1.24	1.16
300	1.35	1.34	1.30	1.34	1.32	1.28	1.31	1.28	1.22	1.30	1.26	1.17
350	1.37	1.35	1.31	1.36	1.34	1.29	1.32	1.30	1.24	1.31	1.27	1.19
400	1.38	1.36	1.32	1.37	1.35	1.30	1.34	1.31	1.25	1.32	1.28	1.20
450	1.39	1.37	1.33	1.38	1.36	1.31	1.35	1.32	1.26	1.33	1.29	1.21
500	1.40	1.38	1.34	1.39	1.37	1.32	1.36	1.33	1.28	1.34	1.30	1.22

NOTE 1 — See 5.3.2.2 for definitions of Class A, Class B and Class C structures.

NOTE 2 — Intermediate values may be obtained by linear interpolation, if desired. It is permissible to assume constant wind speed between 2 heights for simplicity.

**5.3.2.3 Terrain categories in relation to the direction of wind** — The terrain category used in the design of a structure may vary depending on the direction of wind under consideration. Where sufficient meteorological information is available, the basic wind speed may be varied for specific wind direction.

**5.3.2.4 Changes in terrain categories** — The velocity profile for a given terrain category does not develop to full height immediately with the commencement of that terrain category but develop gradually to height ( $h_x$ ) which increases with the fetch or upwind distance ( $x$ ).

a) *Fetch and developed height relationship* — The relation between the developed height ( $h_x$ ) and the fetch ( $x$ ) for wind-flow over each of the four terrain categories may be taken as given in Table 3.

b) For structures of heights greater than the developed height ( $h_x$ ) in Table 3, the velocity profile may be determined in accordance with the following:

- i) The less or least rough terrain, or
- ii) The method described in Appendix B.

**5.3.3 Topography ( $k_3$  Factor)** — The basic wind speed  $V_b$  given in Fig. 1 takes account of the general level of site above sea level. This does not allow for local topographic features such as hills, valleys, cliffs, escarpments, or ridges which can significantly affect wind speed in their vicinity. The effect of topography is to accelerate wind near the summits of hills or crests of cliffs, escarpments or ridges and decelerate the wind in valleys or near the foot of cliffs, steep escarpments, or ridges.

**TABLE 3 FETCH AND DEVELOPED HEIGHT RELATIONSHIP**

( Clause 5.3.2.4 )

FETCH ( $x$ ) km	DEVELOPED HEIGHT, $h_x$ IN METRES			
	Terrain Category 1	Terrain Category 2	Terrain Category 3	Terrain Category 4
(1)	(2)	(3)	(4)	(5)
0.2	12	20	35	60
0.5	20	30	35	95
1	25	45	80	130
2	35	65	110	190
5	60	100	170	300
10	80	140	250	450
20	120	200	350	500
50	180	300	400	500

**5.3.3.1** The effect of topography will be significant at a site when the upwind slope ( $\theta$ ) is greater than about  $3^\circ$ , and below that, the value of  $k_3$  may be taken to be equal to 1.0. The value of  $k_3$  is confined in the range of 1.0 to 1.36 for slopes greater than  $3^\circ$ . A method of evaluating the value of  $k_3$  for values greater than 1.0 is given in Appendix C. It may be noted that the value of  $k_3$  varies with height above ground level, at a maximum near the ground, and reducing to 1.0 at higher levels.

**5.4 Design Wind Pressure** — The design wind pressure at any height above mean ground level shall be obtained by the following relationship between wind pressure and wind velocity:

$$p_z = 0.6 V_z^2$$

where

$p_z$  = design wind pressure in  $N/m^2$  at height  $z$ , and

$V_z$  = design wind velocity in  $m/s$  at height  $z$ .

NOTE — The coefficient 0.6 (in SI units) in the above formula depends on a number of factors and mainly on the atmospheric pressure and air temperature. The value chosen corresponds to the average appropriate Indian atmospheric conditions.

**5.5 Off Shore Wind Velocity** — Cyclonic storms form far away from the sea coast and gradually reduce in speed as they approach the sea coast. Cyclonic storms generally extend up to about 60 kilometres inland after striking the coast. Their effect on land is already reflected in basic wind speeds specified in Fig. 1. The influence of wind speed off the coast up to a distance of about 200 kilometres may be taken as 1.15 times the value on the nearest coast in the absence of any definite wind data.

## 6. WIND PRESSURES AND FORCES ON BUILDINGS/STRUCTURES

**6.1 General** — The wind load on a building shall be calculated for:

- The building as a whole,
- Individual structural elements as roofs and walls, and
- Individual cladding units including glazing and their fixings.

**6.2 Pressure Coefficients** — The pressure coefficients are always given for a particular surface or part of the surface of a building. The wind load acting normal to a surface is obtained by multiplying the area of that surface or its appropriate portion by the pressure coefficient ( $C_p$ ) and the design wind pressure at the height of the surface from the ground. The average values of these pressure coefficients for some building shapes are given in 6.2.2 and 6.2.3.

Average values of pressure coefficients are given for critical wind directions in one or more quadrants. In order to determine the maximum wind load on the building, the total load should be calculated for each of the critical directions shown from all quadrants. Where considerable variation of pressure occurs over a surface, it has been subdivided and mean pressure coefficients given for each of its several parts.

In addition, areas of high local suction (negative pressure concentration) frequently occurring near the edges of walls and roofs are separately shown. Coefficients for the local effects should only be used for calculation of forces on these local areas affecting roof sheeting, glass panels, individual cladding units including their fixtures. They should not be used for calculating force on entire structural elements such as roof, walls or structure as a whole.

NOTE 1 — The pressure coefficients given in different tables have been obtained mainly from measurements on models in wind tunnels, and the great majority of data available has been obtained in conditions of relatively smooth flow. Where sufficient field data exists as in the case of rectangular buildings, values have been obtained to allow for turbulent flow.

NOTE 2 — In recent years, wall glazing and cladding design has been a source of major concern. Although of less consequence than the collapse of main structures, damage to glass can be hazardous and cause considerable financial losses.

NOTE 3 — For pressure coefficients for structures not covered here, reference may be made to specialist literature on the subject or advice may be sought from specialists in the subject.

**6.2.1 Wind Load on Individual Members** — When calculating the wind load on individual structural elements such as roofs and walls, and individual cladding units and their fittings, it is essential to take account of the pressure difference between opposite faces of such elements or units. For clad structures, it is, therefore, necessary to know the internal pressure as well as the external pressure. Then the wind load,  $F$ , acting in a direction normal to the individual structural element or cladding unit is:

$$F = (C_{pe} - C_{pi}) A p_d$$

where

$C_{pe}$  = external pressure coefficient,

$C_{pi}$  = internal pressure coefficient,

$A$  = surface area of structural element or cladding unit, and

$p_d$  = design wind pressure.

NOTE 1 — If the surface design pressure varies with height, the surface areas of the structural element may be sub-divided so that the specified pressures are taken over appropriate areas.

NOTE 2 — Positive wind load indicates the force acting towards the structural element and negative away from it.

### 6.2.2 External Pressure Coefficients

**6.2.2.1 Walls** — The average external pressure coefficient for the walls of clad buildings of rectangular plan shall be as given in Table 4. In addition, local pressure concentration coefficients are also given.



**6.2.2.2 Pitched roofs of rectangular clad buildings** — The average external pressure coefficients and pressure concentration coefficients for pitched roofs of rectangular clad building shall be as given in Table 5. Where no pressure concentration coefficients are given, the average coefficients shall apply. The pressure coefficients on the underside of any overhanging roof shall be taken in accordance with 6.2.2.7.

NOTE 1 — The pressure concentration shall be assumed to act outward (suction pressure) at the ridges, eaves, cornices and 90 degree corners of roofs (see 6.2.2.7).

NOTE 2 — The pressure concentration shall not be included with the net external pressure when computing overall loads.

**TABLE 4 EXTERNAL PRESSURE COEFFICIENTS (  $C_{pe}$  ) FOR WALLS OF RECTANGULAR CLAD BUILDINGS**

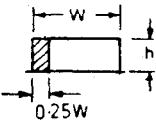
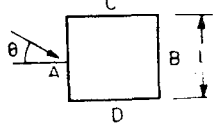
( Clause 6.2.2.1 )

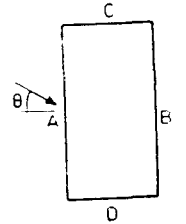
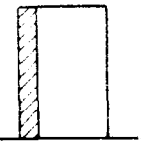
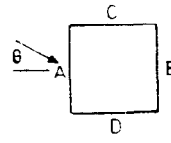
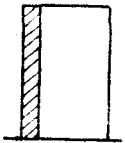
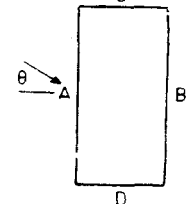
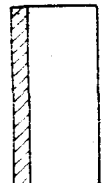
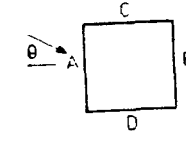
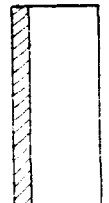
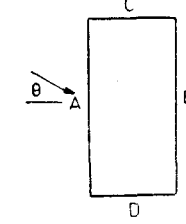
BUILDING HEIGHT RATIO	BUILDING PLAN RATIO	ELEVATION	PLAN	WIND ANGLE $\theta$	$C_{pe}$ FOR SURFACE				LOCAL $C_{pe}$ 
					A	B	C	D	
$\frac{h}{w} < \frac{1}{2}$	$1 < \frac{l}{w} < \frac{3}{2}$			degrees					
				0	+0.7	-0.2	-0.5	-0.5	} -0.8
90	-0.5	-0.5	+0.7	-0.2					
	$\frac{3}{2} < \frac{l}{w} < 4$			0	+0.7	-0.25	-0.6	-0.6	} -1.0
				90	-0.5	-0.5	+0.7	-0.1	
$\frac{1}{2} < \frac{h}{w} < \frac{3}{2}$	$1 < \frac{l}{w} < \frac{3}{2}$			0	+0.7	-0.25	-0.6	-0.6	} -1.1
				90	-0.6	-0.6	+0.7	-0.25	
	$\frac{3}{2} < \frac{l}{w} < 4$			0	+0.7	-0.3	-0.7	-0.7	} -1.1
				90	-0.5	-0.5	+0.7	-0.1	
$\frac{3}{2} < \frac{h}{w} < 6$	$1 < \frac{l}{w} < \frac{3}{2}$			0	+0.8	-0.25	-0.8	-0.8	} -1.2
				90	-0.8	-0.8	+0.8	-0.25	
	$\frac{3}{2} < \frac{l}{w} < 4$			0	+0.7	-0.4	-0.7	-0.7	} -1.2
				90	-0.5	-0.5	+0.8	-0.1	

( Continued )

**TABLE 4 EXTERNAL PRESSURE COEFFICIENTS (  $C_{pe}$  ) FOR WALLS OF RECTANGULAR CLAD BUILDINGS — Contd**

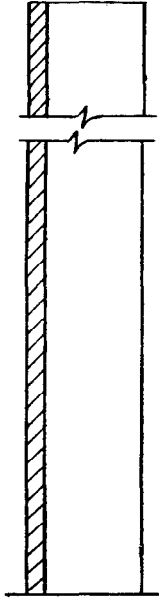
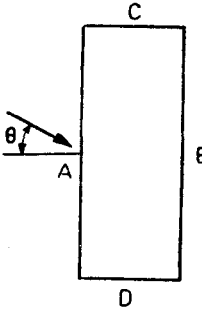
BUILDING HEIGHT RATIO	BUILDING PLAN RATIO	ELEVATION	PLAN	WIND ANGLE $\theta$	$C_{pe}$ FOR SURFACE				LOCAL $C_{pe}$ 
					A	B	C	D	
$\frac{h}{w} > \infty$	$\frac{l}{w} = \frac{3}{2}$			0	+0.95	-1.85	-0.9	-0.9	} -1.25
				90	-0.8	-0.8	+0.9	-0.85	
	$\frac{l}{w} = 1.0$			0	+0.95	-1.25	-0.7	-0.7	} -1.25
				90	-0.7	-0.7	+0.95	-1.25	
	$\frac{l}{w} = 2$			0	+0.85	-0.75	-0.75	-0.75	} -1.25
				90	-0.75	-0.75	+0.85	-0.75	

NOTE —  $h$  is the height to eaves or parapet,  $l$  is the greater horizontal dimension of a building and  $w$  is the lesser horizontal dimension of a building.

**6.2.2.3 Monoslope roofs of rectangular clad buildings** — The average pressure coefficient and pressure concentration coefficient for monoslope (lean-to) roofs of rectangular clad buildings shall be as given in Table 6.

**6.2.2.4 Canopy roofs with  $\left(\frac{l}{4} < \frac{h}{w} < 1 \text{ and } 1 < \frac{L}{w} < 3\right)$**  — The pressure coefficients are given in Tables 7 and 8 separately for mono-pitch and double pitch canopy roofs such as open-air parking garages, shelter areas, outdoor areas, railway platforms, stadiums and theatres. The coefficients take account of the combined effect of the wind exerted on and under the roof for all wind directions; the resultant is to be taken normal to the canopy. Where the local coefficients overlap, the greater of the two given values should be taken. However, the effect of partial closures of one side and or both sides, such as those due to trains, buses and stored materials shall be foreseen and taken into account.

The solidity ratio  $\phi$  is equal to the area of obstructions under the canopy divided by the gross area under the canopy, both areas normal

to the wind direction.  $\phi = 0$  represents a canopy with no obstructions underneath.  $\phi = 1$  represents the canopy fully blocked with contents to the downwind eaves. Values of  $C_p$  for intermediate solidities may be linearly interpolated between these two extremes, and apply upwind of the position of maximum blockage only. Downwind of the position of maximum blockage the coefficients for  $\phi = 0$  may be used.

In addition to the pressure forces normal to the canopy, there will be horizontal loads on the canopy due to the wind pressure on any fascia and to friction over the surface of the canopy. For any wind direction, only the greater of these two forces need be taken into account. Fascia loads should be calculated on the area of the surface facing the wind, using a force coefficient of 1.3. Frictional drag should be calculated using the coefficients given in 6.3.1.

NOTE — Tables 9 to 14 may be used to get internal and external pressure coefficients for pitches and troughed free roofs for some specific cases for which aspect ratios and roof slopes have been specified. However, while using Tables 9 to 14 any significant departure from it should be investigated carefully. No increase shall be made for local effects except as indicated.



TABLE 5 EXTERNAL PRESSURE COEFFICIENTS (  $C_{pe}$  ) FOR PITCHED ROOFS OF RECTANGULAR CLAD BUILDINGS

( Clause 6.2.2.2 )

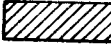
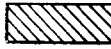
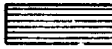
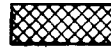
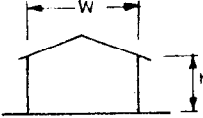
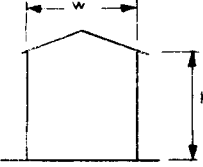
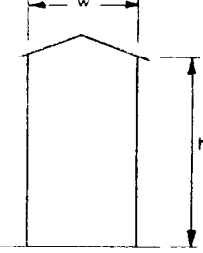
BUILDING HEIGHT RATIO	ROOF ANGLE $\alpha$	WIND ANGLE $\theta$ 0°		WIND ANGLE $\theta$ 90°		LOCAL COEFFICIENTS			
		EF	GH	EG	FH				
$\frac{h}{w} \leq \frac{1}{2}$ 	degrees								
	0	-0.8	-0.4	-0.8	-0.4	-2.0	-2.0	-2.0	-
	5	-0.9	-0.4	-0.8	-0.4	-1.4	-1.2	-1.2	-1.0
	10	-1.2	-0.4	-0.8	-0.6	-1.4	-1.4	-	-1.2
	20	-0.4	-0.4	-0.7	-0.6	-1.0	-	-	-1.2
	30	0	-0.4	-0.7	-0.6	-0.8	-	-	-1.1
	45	+0.3	-0.5	-0.7	-0.6	-	-	-	-1.1
60	+0.7	-0.6	-0.7	-0.6	-	-	-	-1.1	
$\frac{1}{2} < \frac{h}{w} \leq \frac{3}{2}$ 	0	-0.8	-0.6	-1.0	-0.6	-2.0	-2.0	-2.0	-
	5	-0.9	-0.6	-0.9	-0.6	-2.0	-2.0	-1.5	-1.0
	10	-1.1	-0.6	-0.8	-0.6	-2.0	-2.0	-1.5	-1.2
	20	-0.7	-0.5	-0.8	-0.6	-1.5	-1.5	-1.5	-1.0
	30	-0.2	-0.5	-0.8	-0.8	-1.0	-	-	-1.0
	45	+0.2	-0.5	-0.8	-0.8	-	-	-	-
	60	+0.6	-0.5	-0.8	-0.8	-	-	-	-
$\frac{3}{2} < \frac{h}{w} < 6$ 	0	-0.7	-0.6	-0.9	-0.7	-2.0	-2.0	-2.0	-
	5	-0.7	-0.6	-0.8	-0.8	-2.0	-2.0	-1.5	-1.0
	10	-0.7	-0.6	-0.8	-0.8	-2.0	-2.0	-1.5	-1.2
	20	-0.8	-0.6	-0.8	-0.8	-1.5	-1.5	-1.5	-1.2
	30	-1.0	-0.5	-0.8	-0.7	-1.5	-	-	-
	40	-0.2	-0.5	-0.8	-0.7	-1.0	-	-	-
	50	+0.2	-0.5	-0.8	-0.7	-	-	-	-
60	+0.5	-0.5	-0.8	-0.7	-	-	-	-	

NOTE 1 —  $h$  is the height to eaves or parapet and  $w$  is the lesser horizontal dimension of a building.

NOTE 2 — Where no local coefficients are given, the overall coefficients apply.

NOTE 3 — For hipped roofs the local coefficient for the hip ridge may be conservatively taken as the appropriate ridge value.

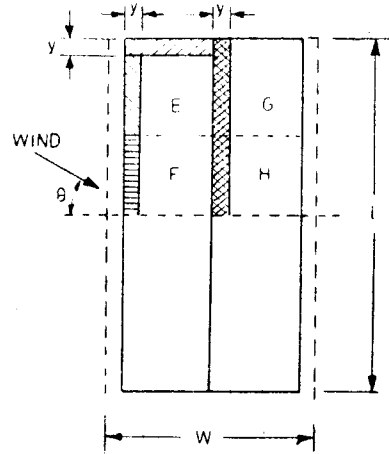

KEY PLAN

$y = h$  or  $0.15 w$ ,  
whichever is the lesser.

**TABLE 6 EXTERNAL PRESSURE COEFFICIENTS (  $C_{pe}$  ) FOR MONOSLOPE ROOFS FOR RECTANGULAR CLAD BUILDINGS WITH  $\frac{h}{w} < 2$**

( Clause 6.2.2.3 )

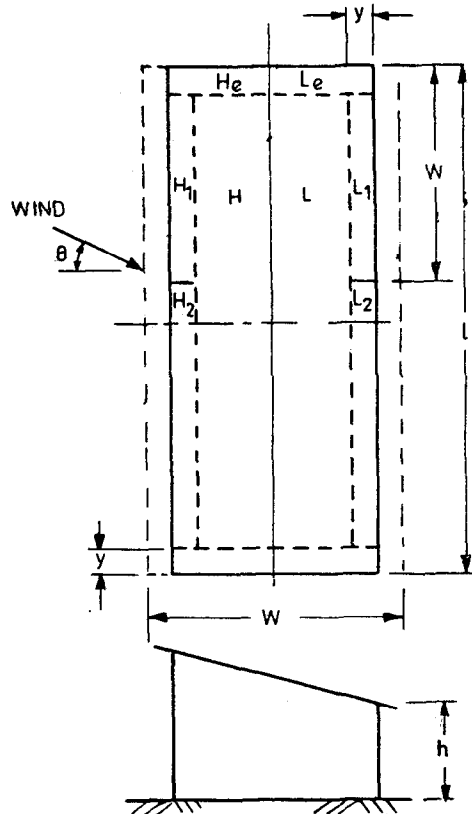

$y = h$  or  $0.15 w$ , whichever is the lesser.

NOTE — Area  $H$  and area  $L$  refer to the whole quadrant.

ROOF ANGLE $\alpha$	WIND ANGLE $\theta$										LOCAL $C_{pe}$					
	0°		45°		90°		135°		180°		$H_1$	$H_2$	$L_1$	$L_2$	$H_e$	$L_e$
Degree	$H$	$L$	$H$	$L$	$H \& L$	$H \& L$	$H$	$L$	$H$	$L$	$H_1$	$H_2$	$L_1$	$L_2$	$H_e$	$L_e$
5	-1.0	-0.5	-1.0	-0.9	-1.0	-0.5	-0.9	-1.0	-0.5	-1.0	-2.0	-1.5	-2.0	-1.5	-2.0	-2.0
10	-1.0	-0.5	-1.0	-0.8	-1.0	-0.5	-0.8	-1.0	-0.4	-1.0	-2.0	-1.5	-2.0	-1.5	-2.0	-2.0
15	-0.9	-0.5	-1.0	-0.7	-1.0	-0.5	-0.6	-1.0	-0.3	-1.0	-1.8	-0.9	-1.8	-1.4	-2.0	-2.0
20	-0.8	-0.5	-1.0	-0.6	-0.9	-0.5	-0.5	-1.0	-0.2	-1.0	-1.8	-0.8	-1.8	-1.4	-2.0	-2.0
25	-0.7	-0.5	-1.0	-0.6	-0.8	-0.5	-0.3	-0.9	-0.1	-0.9	-1.8	-0.7	-0.9	-0.9	-2.0	-2.0
30	-0.5	-0.5	-1.0	-0.6	-0.8	-0.5	-0.1	-0.6	0	-0.6	-1.8	-0.5	-0.5	-0.5	-2.0	-2.0

NOTE —  $h$  is the height to eaves at lower side,  $l$  is the greater horizontal dimension of a building and  $w$  is the lesser horizontal dimension of a building.

**TABLE 7 PRESSURE COEFFICIENTS FOR MONOSLOPE FREE ROOFS**

( Clause 6.2.2.4 )

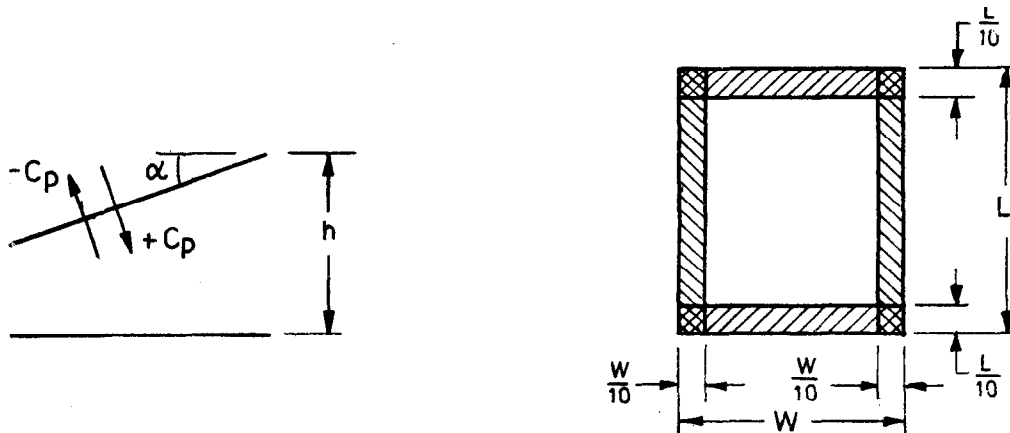

ROOF ANGLE ( DEGREES )	SOLIDITY RATIO	MAXIMUM ( LARGEST + VE ) AND MINIMUM ( LARGEST - VE ) PRESSURE COEFFICIENTS			
		Overall Coefficients	Local Coefficients		
			□	▨	▨
0	All values of $\phi$	+0.2	+0.5	+1.8	+1.1
5		+0.4	+0.8	+2.1	+1.3
10		+0.5	+1.2	+2.4	+1.6
15		+0.7	+1.4	+2.7	+1.8
20		+0.8	+1.7	+2.9	+2.1
25		+1.0	+2.0	+3.1	+2.3
30		+1.2	+2.2	+3.2	+2.4
0	$\phi=0$	-0.5	-0.6	-1.3	-1.4
	$\phi=1$	-1.0	-1.2	-1.8	-1.9
5	$\phi=0$	-0.7	-1.1	-1.7	-1.8
	$\phi=1$	-1.1	-1.6	-2.2	-2.3
10	$\phi=0$	-0.9	-1.5	-2.0	-2.1
	$\phi=1$	-1.3	-2.1	-2.6	-2.7
15	$\phi=0$	-1.1	-1.8	-2.4	-2.5
	$\phi=1$	-1.4	-2.3	-2.9	-3.0
20	$\phi=0$	-1.3	-2.2	-2.8	-2.9
	$\phi=1$	-1.5	-2.6	-3.1	-3.2
25	$\phi=0$	-1.6	-2.6	-3.2	-3.2
	$\phi=1$	-1.7	-2.8	-3.5	-3.5
30	$\phi=0$	-1.8	-3.0	-3.8	-3.6
	$\phi=1$	-1.8	-3.0	-3.8	-3.6

NOTE — For monopitch canopies the centre of pressure should be taken to act at  $0.3 w$  from the windward edge.

**TABLE 8 PRESSURE COEFFICIENTS FOR FREE STANDING DOUBLE SLOPED ROOFS**  
( Clause 6.2.2.4 )

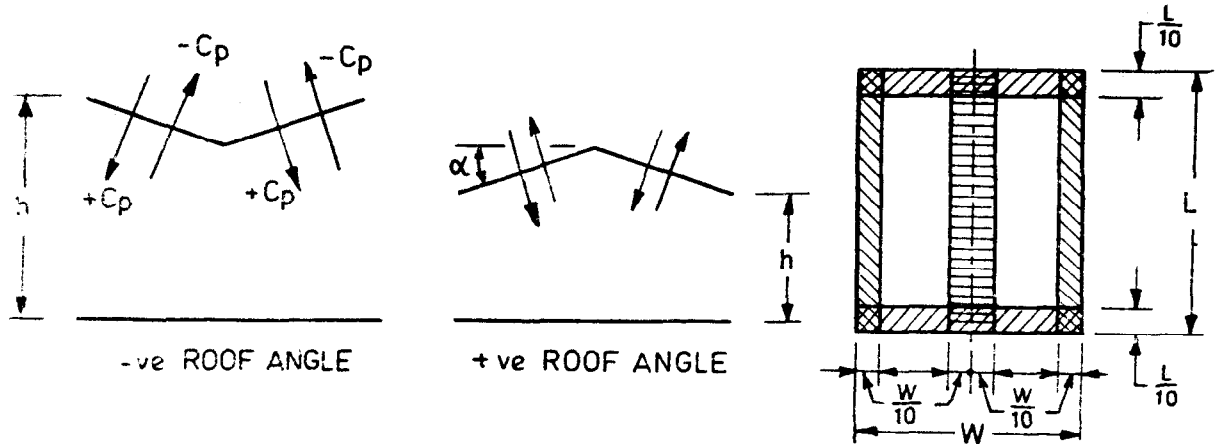

ROOF ANGLE ( DEGREES )	SOLIDITY RATIO	MAXIMUM ( LARGEST +ve ) AND MINIMUM ( LARGEST - ve ) PRESSURE COEFFICIENTS				
		Overall Coefficients	Local Coefficients			
-20 -15 -10 -5 +5 +10 +15 +20 +25 +30	All values of $\phi$	+0.7	+0.8	+1.6	+0.6	+1.7
		+0.5	+0.6	+1.5	+0.7	+1.4
		+0.4	+0.6	+1.4	+0.8	+1.1
		+0.3	+0.5	+1.5	+0.8	+0.8
		+0.3	+0.6	+1.8	+1.3	+0.4
		+0.4	+0.7	+1.8	+1.4	+0.4
		+0.4	+0.9	+1.9	+1.4	+0.4
		+0.6	+1.1	+1.9	+1.5	+0.4
		+0.7	+1.2	+1.9	+1.6	+0.5
		+0.9	+1.3	+1.9	+1.6	+0.7
		-20 -15 -10 -5 +5 +10 +15 +20 +25 +30	$\phi=0$ $\phi=1$	-0.7 -0.9	-0.9 -1.2	-1.3 -1.7
$\phi=0$ $\phi=1$	-0.6 -0.8			-0.8 -1.1	-1.3 -1.7	-1.6 -1.9
	$\phi=0$ $\phi=1$		-0.6 -0.8	-0.8 -1.1	-1.3 -1.7	-1.5 -1.9
$\phi=0$ $\phi=1$			-0.5 -0.8	-0.7 -1.5	-1.3 -1.7	-1.6 -1.9
	$\phi=0$ $\phi=1$		-0.6 -0.9	-0.6 -1.3	-1.4 -1.8	-1.4 -1.8
$\phi=0$ $\phi=1$			-0.7 -1.1	-0.7 -1.4	-1.5 -2.0	-1.4 -1.8
	$\phi=0$ $\phi=1$		-0.8 -1.2	-0.9 -1.5	-1.7 -2.2	-1.4 -1.9
$\phi=0$ $\phi=1$			-0.9 -1.3	-1.2 -1.7	-1.8 -2.3	-1.4 -1.9
	$\phi=0$ $\phi=1$		-1.0 -1.4	-1.4 -1.9	-1.9 -2.4	-1.4 -2.1
$\phi=0$ $\phi=1$			-1.0 -1.4	-1.4 -2.1	-1.9 -2.6	-1.4 -2.2

Each slope of a duopitch canopy should be able to withstand forces using both the maximum and the minimum coefficients, and the whole canopy should be able to support forces using one slope at the maximum coefficient with the other slope at the minimum coefficient. For duopitch canopies the centre of pressure should be taken to act at the centre of each slope.

**TABLE 9 PRESSURE COEFFICIENTS ( TOP AND BOTTOM ) FOR PITCHED ROOFS,  $\alpha = 30^\circ$**

( Clause 6.2.2.4 )

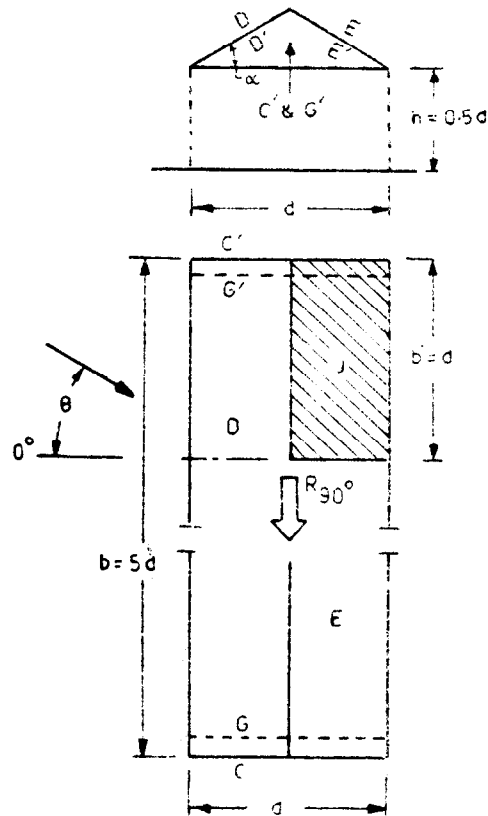

Roof slope  $\alpha = 30^\circ$   
 $\theta = 0^\circ - 45^\circ$ ,  $D, D', E, E'$  full length  
 $\theta = 90^\circ$ ,  $D, D', E, E'$  part length  
 $b'$ , thereafter  $C_p = 0$

$\theta$	PRESSURE COEFFICIENTS, $C_p$							
	$D$	$D'$	$E$	$E'$	End Surfaces			
					$C$	$C'$	$G$	$G'$
$0^\circ$	0.6	-1.0	-0.5	-0.9				
$45^\circ$	0.1	-0.3	-0.6	-0.3				
$90^\circ$	-0.3	-0.4	-0.3	-0.4	-0.3	0.8	0.3	0.4
$45^\circ$	For $j$ : $C_p$ top = -1.0; $C_p$ bottom = -0.2							
$90^\circ$	Tangentially acting friction: $R_{90^\circ} = 0.05 pabd$							

**TABLE 10 PRESSURE COEFFICIENTS ( TOP AND BOTTOM ) FOR PITCHED FREE ROOFS,  
 $\alpha = 30^\circ$  WITH EFFECTS OF TRAIN OR STORED MATERIALS**

( Clause 6.2.2.4 )

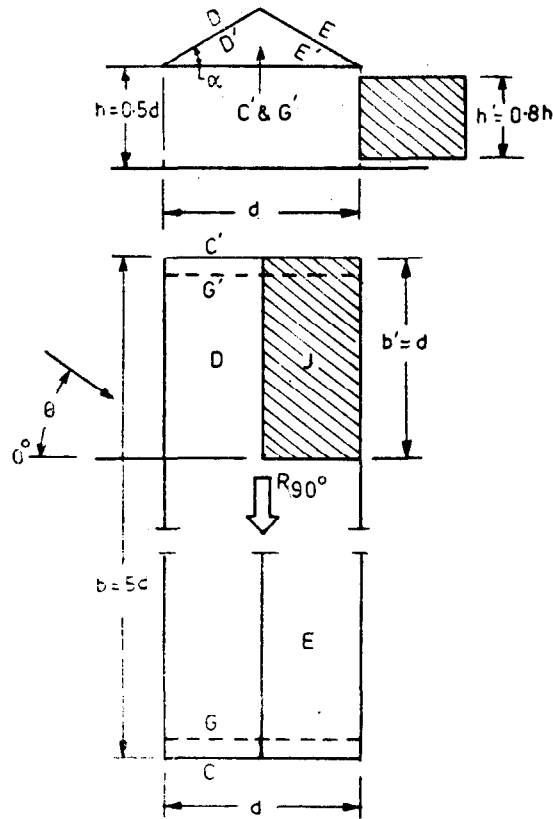

Roof slope  $\alpha = 30^\circ$   
 Effects of trains or stored materials:  
 $\theta = 0^\circ - 45^\circ$ , or  $135^\circ - 180^\circ$ ,  
 $D, D', E, E'$  full length  
 $\theta = 90^\circ$ ,  $D, D', E, E'$  part length  $b'$ , thereafter  $C_p = 0$

$\theta$	PRESSURE COEFFICIENTS, $C_p$							
	$D$	$D'$	$E$	$E'$	End Surfaces			
					$C$	$C'$	$G$	$G'$
$0^\circ$	0.1	0.8	-0.7	0.9				
$45^\circ$	-0.1	0.5	-0.8	0.5				
$90^\circ$	-0.4	-0.5	-0.4	-0.5	-0.3	0.8	0.3	-0.4
$180^\circ$	-0.3	-0.6	0.4	-0.6				
$45^\circ$	For $j$ : $C_p$ top = -1.5; $C_p$ bottom = 0.5							
$90^\circ$	Tangentially acting friction: $R_{90} = 0.05 \rho_a b d$							

**TABLE 11 PRESSURE COEFFICIENTS ( TOP AND BOTTOM ) FOR PITCHED FREE ROOFS,  $\alpha = 10^\circ$**   
( Clause 6.2.2.4 )

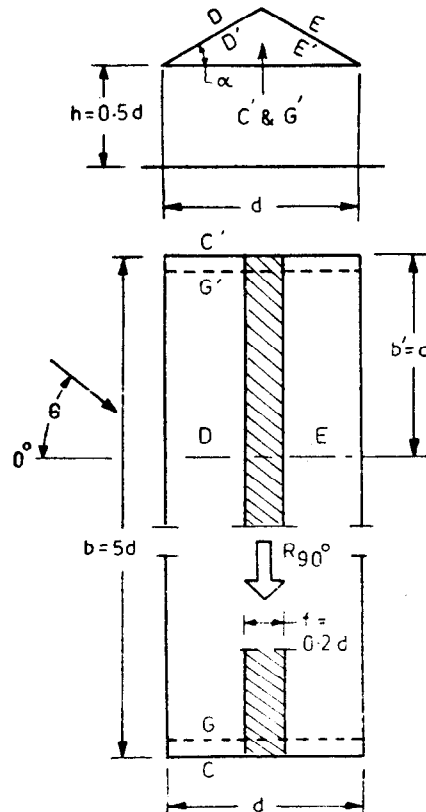

Roof slope  $\alpha = 10^\circ$   
 $\theta = 0^\circ - 45^\circ$ ,  $D, D', E, E'$  full length  
 $\theta = 90^\circ$ ,  $D, D', E, E'$  part length  $b'$ ,  
 thereafter  $C_p = 0$

$\theta$	PRESSURE COEFFICIENTS, $C_p$							
	$D$	$D'$	$E$	$E'$	End Surfaces			
					$C$	$C'$	$G$	$G'$
$0^\circ$	-1.0	0.3	-0.5	0.2				
$45^\circ$	-0.3	0.1	-0.3	0.1				
$90^\circ$	-0.3	0	-0.3	0	-0.4	0.8	0.3	-0.6
$0^\circ$ $0^\circ - 90^\circ$	For $f$ : $C_p$ top = -1.0; $C_p$ bottom = 0.4 Tangentially acting friction, $R_{90^\circ} = 0.1 p a b d$							



**TABLE 12. PRESSURE COEFFICIENTS (TOP AND BOTTOM) FOR PITCHED FREE ROOFS**  
 $\alpha = 10^\circ$  WITH EFFECTS OF TRAIN OR STORED MATERIALS  
 ( Clause 6.2.2.4 )

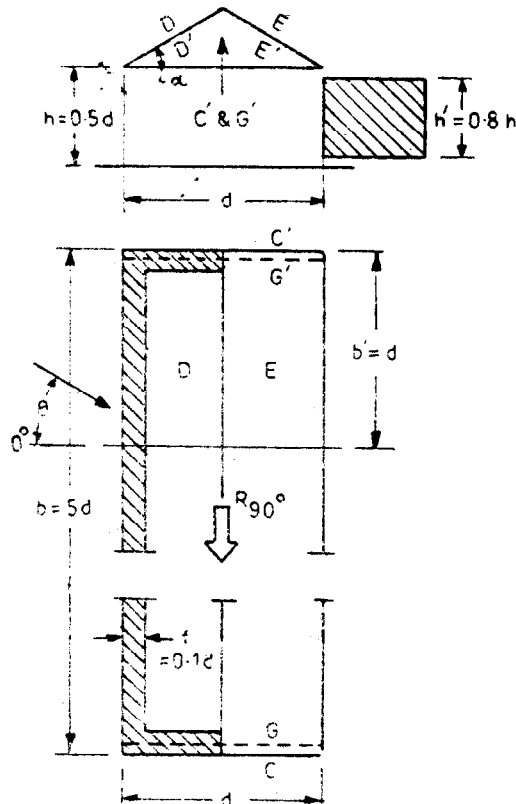

Roof slope  $\alpha = 10^\circ$   
 Effects of trains or stored materials:  
 $\theta = 0^\circ - 45^\circ$ , or  $135^\circ - 180^\circ$ ,  
 $D, D', E, E'$  full length  
 $\theta = 90^\circ$ ,  $D, D', E, E'$  part length  $b'$ ,  
 thereafter  $C_p = 0$

$\theta$	PRESSURE COEFFICIENTS, $C_p$							
	$D$	$D'$	$E$	$E'$	End Surfaces			
					$C$	$C'$	$G$	$G'$
$0^\circ$	-1.3	0.8	-0.6	0.7				
$45^\circ$	-0.5	0.4	-0.3	0.3				
$90^\circ$	-0.3	0	-0.3	0	-0.4	0.8	0.3	-0.6
$180^\circ$	-0.4	-0.3	-0.6	-0.3				
$0^\circ$ $0^\circ - 180^\circ$	For $f$ : $C_p$ top = -1.6; $C_p$ bottom = 0.9 Tangentially acting friction: $R_{90^\circ} = 0.1 pabd$							



**TABLE 14 PRESSURE COEFFICIENTS ( TOP AND BOTTOM ) FOR TROUGHED FREE ROOFS,  
 $\alpha = 10^\circ$  WITH EFFECTS OF TRAINS OR STORED MATERIALS**

( Clause 6.2.2.4 )

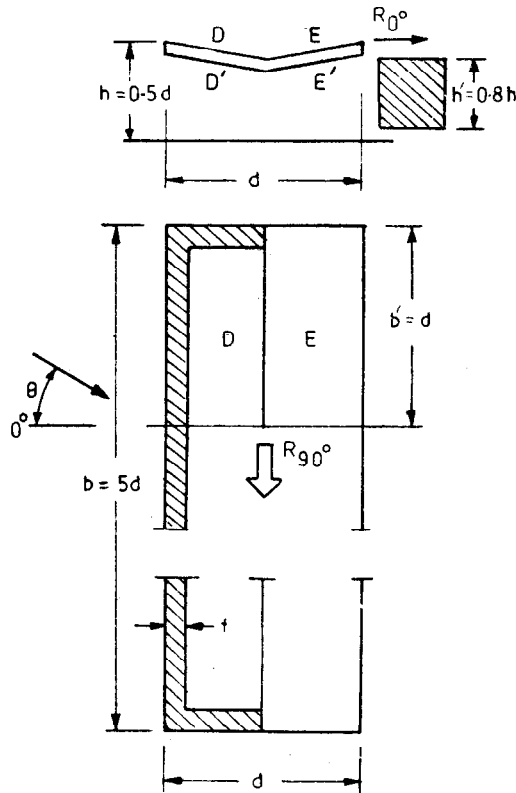

Roof slope  $\alpha = 10^\circ$   
 Effects of trains or stored materials:  
 $\theta = 0^\circ - 45^\circ$ , or  $135^\circ - 180^\circ$ ,  
 $D, D', E, E'$  full length  
 $\theta = 90^\circ$ ,  $D, D', E, E'$ , part length  $b'$  thereafter  $C_p = 0$

$\theta$	PRESSURE COEFFICIENTS, $C_p$			
	$D$	$D'$	$E$	$E'$
$0^\circ$	-0.7	0.8	-0.6	0.6
$45^\circ$	-0.4	0.3	-0.2	0.2
$90^\circ$	-0.1	0.1	-0.1	0.1
$180^\circ$	-0.4	-0.2	-0.6	-0.3
$0^\circ$ $0^\circ - 180^\circ$	For $f$ : $C_p$ top = -1.1; $C_p$ bottom = 0.9 Tangentially acting friction: $R_{90^\circ} = 0.1 pabd$			

**6.2.2.5 Curved roofs** — For curved roofs, the external pressure coefficients shall be as given in Table 15. Allowance for local effects shall be made in accordance with Table 5.

**6.2.2.6 Pitched and saw-tooth roofs of multi-span buildings** — For pitched and saw-tooth roofs of multi-span buildings, the external average pressure coefficients and pressure concentration coefficients shall be as given in Tables 16 and 17 respectively, provided that all spans shall be equal and the height to the eaves shall not exceed the span.

NOTE — Evidence on multi-span buildings is fragmentary; any departure given in Tables 16 and 17 should be investigated separately.

**6.2.2.7 Pressure coefficients on overhangs from roofs** — The pressure coefficients on the top overhanging portion of the roofs shall be taken to be the same as that of the nearest top portion of the non-overhanging portion of the roofs. The pressure coefficients for the underside surface of the overhanging portions shall be taken as follows and shall be taken as positive if the overhanging portion is on the windward side:

- a) 1.25 if the overhanging slopes,
- b) 1.00 if the overhanging is horizontal, and
- c) 0.75 if the overhanging slopes upwards.

For overhanging portions on sides other than the windward side, the average pressure coefficients on adjoining walls may be used.

**6.2.2.8 Cylindrical structures** — For the purpose of calculating the wind pressure distribution around a cylindrical structure of circular cross-section, the value of external pressure coefficients given in Table 18 may be used provided that the Reynolds number is greater than 10 000. They may be used for wind blowing normal to the axis of cylinders having axis normal to the ground plane ( that is, chimneys and silos ) and cylinders having their axis parallel to the ground plane ( that is, horizontal tanks ) provided that the clearance between the tank and the ground is not less than the diameter of the cylinder.

$h$  is height of a vertical cylinder or length of a horizontal cylinder. Where there is a free flow of air around both ends,  $h$  is to be taken as half the length when calculating  $h/D$  ratio.

In the calculation of the resultant load on the periphery of the cylinder, the value of  $C_{p1}$  shall be taken into account. For open ended cylinders,  $C_{p1}$  shall be taken as follows:

- a) 0.8 where  $h/D$  is not less than 0.3, and
- b) 0.5 where  $h/D$  is less than 0.3.

**6.2.2.9 Roofs and bottoms of cylindrical elevated structures** — The external pressure coefficients for roofs and bottoms of cylindrical elevated structures shall be as given in Table 19 ( see also Fig. 2 ).

The total resultant load ( $P$ ) acting on the roof of the structure is given by the following formula:

$$P = 0.785 D^3 ( p_1 - C_{pe} p_d )$$

The resultant of  $P$  for roofs lies at  $0.1 D$  from the centre of the roof on the windward side.

**6.2.2.10 Combined roofs and roofs with a sky light** — The average external pressure coefficients for combined roofs and roofs with a sky light is shown in Table 20.

**6.2.2.11 Grandstands** — The pressure coefficients on the roof ( top and bottom ) and rear wall of a typical grandstand roof which is open on three sides is given in Table 21. The pressure coefficients are valid for a particular ratio of dimensions as specified in Table 21 but may be used for deviations up to 20 percent. In general, the maximum wind load occurs when the wind is blowing into the open front of the stand, causing positive pressure under the roof and negative pressure on the roof.

**6.2.2.12 Upper surface of round silos and tanks** — The pressure coefficients on the upper surface of round silos and tanks standing on ground shall be as given in Fig. 2.

**6.2.2.13 Spheres** — The external pressure coefficients for spheres shall be as given in Table 22.

**6.2.3 Internal Pressure Coefficients** — Internal air pressure in a building depends upon the degree of permeability of cladding to the flow of air. The internal air pressure may be positive or negative depending on the direction of flow of air in relation to openings in the buildings.

**6.2.3.1** In the case of buildings where the claddings permit the flow of air with openings not more than about 5 percent of the wall area but where there are no large openings, it is necessary to consider the possibility of the internal pressure being positive or negative. Two design conditions shall be examined, one with an internal pressure coefficient of  $+0.2$  and another with an internal pressure coefficient of  $-0.2$ .

The internal pressure coefficient is algebraically added to the external pressure coefficient and the analysis which indicates greater distress of the member shall be adopted. In most situations a simple inspection of the sign of external pressure will at once indicate the proper sign of the internal pressure coefficient to be taken for design.

NOTE — The term normal permeability relates to the flow of air commonly afforded by claddings not only through open windows and doors, but also through the slits round the closed windows and doors and through chimneys, ventilators and through the joints between roof coverings, the total open area being less than 5 percent of area of the walls having the openings.

**TABLE 15 EXTERNAL PRESSURE COEFFICIENTS FOR CURVED ROOFS**

( Clause 6.2.2.5 )

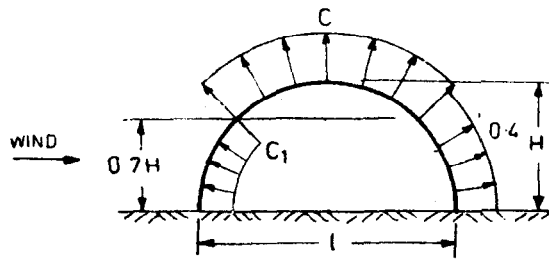

a) Roof springing from ground level

Values of C, C<sub>1</sub> and C<sub>2</sub>

H/l	C	C <sub>1</sub>	C <sub>2</sub>
0.1	-0.8	+0.1	-0.8
0.2	-0.9	+0.3	-0.7
0.3	-1.0	+0.4	-0.3
0.4	-1.1	+0.6	+0.4
0.5	-1.2	+0.7	+0.7

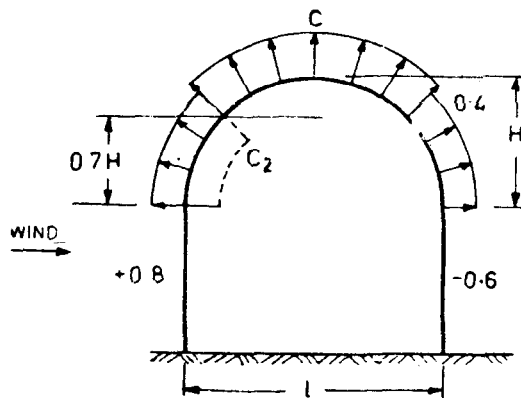

b) Roof on elevated structure

NOTE — When the wind is blowing normal to gable ends, C<sub>pe</sub> may be taken as equal to -0.7 for the full width of the roof over a length of l/2 from the gable ends and -0.5 for the remaining portion.

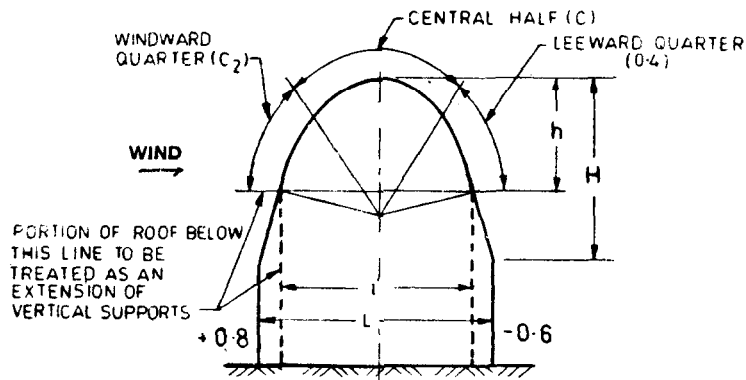

c) Doubly curved roofs

$$\frac{H}{l} > 0.6$$

$$\frac{h}{L} > 0.6$$

**TABLE 16 EXTERNAL PRESSURE COEFFICIENTS (  $C_{pe}$  ) FOR PITCHED ROOFS OF MULTISPAN BUILDINGS ( ALL SPANS EQUAL ) WITH  $h > w'$**   
( Clause 6.2.2.6 )

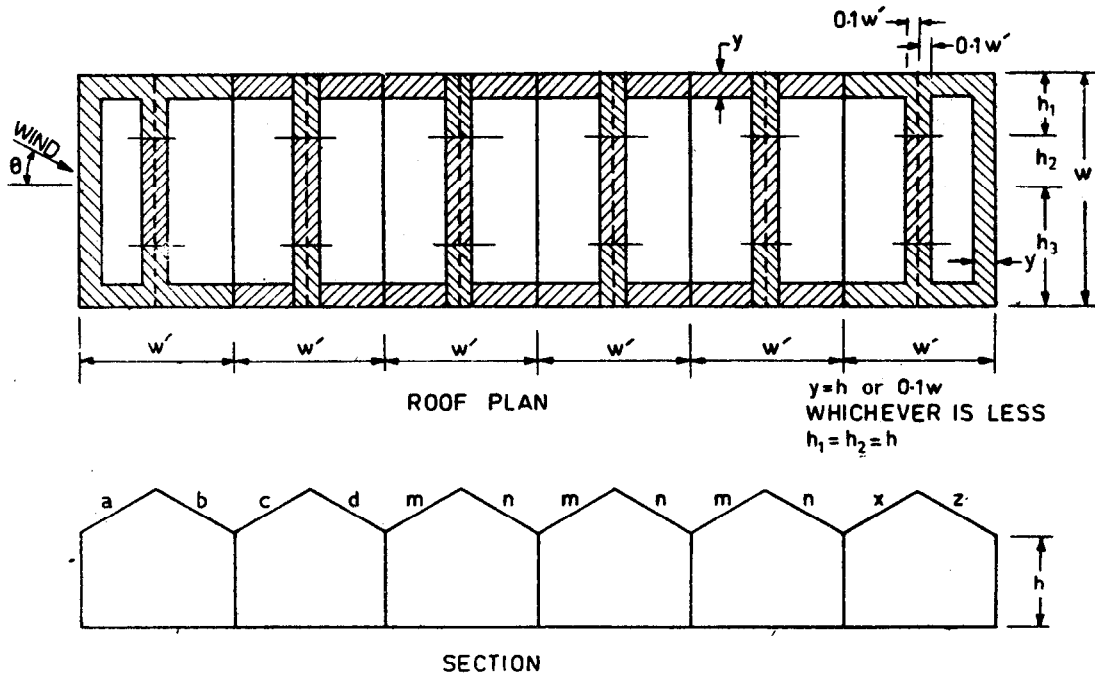

ROOF ANGLE $\alpha$	WIND ANGLE $\theta$	FIRST SPAN		FIRST INTERMEDIATE SPAN		OTHER INTERMEDIATE SPAN		END SPAN		LOCAL COEFFICIENT	
		a	b	c	d	m	n	x	z		
degrees	degrees										
5	0	-0.9	-0.6	-0.4	-0.3	-0.3	-0.3	-0.3	-0.3	-2.0	-1.5
10		-1.1	-0.6	-0.4	-0.3	-0.3	-0.3	-0.3	-0.4		
20		-0.7	-0.6	-0.4	-0.3	-0.3	-0.3	-0.3	-0.5		
30		-0.2	-0.6	-0.4	-0.3	-0.2	-0.3	-0.2	-0.5		
45		+0.3	-0.6	-0.6	-0.4	-0.2	-0.4	-0.2	-0.5		

Roof Angle $\alpha$ degrees	Wind Angle $\theta$ degrees	Distance		
		$h_1$	$h_2$	$h_3$
Up to 45	90	-0.8	-0.6	-0.2

Frictional drag: When wind angle  $\theta = 0^\circ$ , horizontal forces due to frictional drag are allowed for in the above values; and

when wind angle  $\theta = 90^\circ$ , allow for frictional drag in accordance with 6.3.1.

NOTE — Evidence on these buildings is fragmentary and any departure from the cases given should be investigated separately.

**TABLE 17 EXTERNAL PRESSURE COEFFICIENTS  $C_{pe}$  FOR SAW-TOOTH ROOFS OF MULTI-SPAN BUILDINGS ( ALL SPANS EQUAL ) WITH  $h > w'$**   
( Clause 6.2.2.6 )

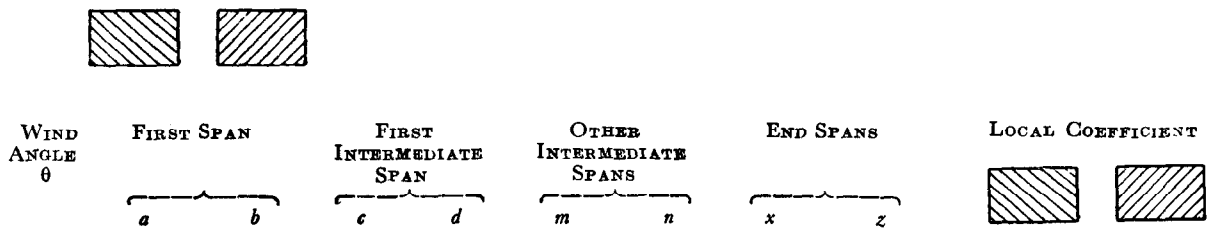
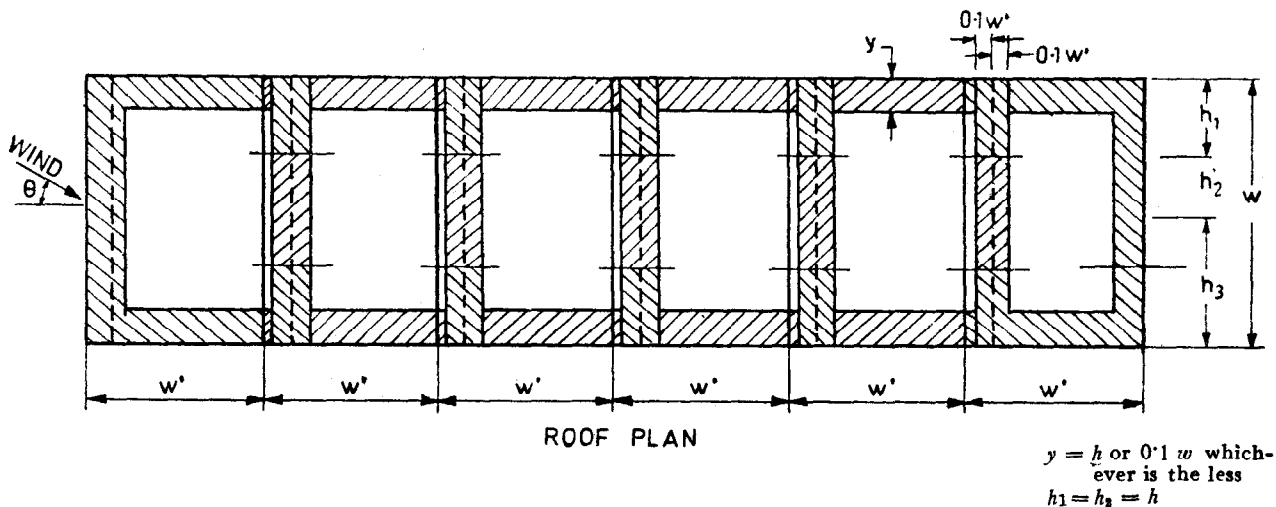

WIND ANGLE $\theta$	FIRST SPAN		FIRST INTERMEDIATE SPAN		OTHER INTERMEDIATE SPANS		END SPANS		LOCAL COEFFICIENT	
degrees	a	b	c	d	m	n	x	z		
0	+0.6	-0.7	-0.7	-0.4	-0.3	-0.2	-0.1	-0.3	-2.0	-1.5
180	-0.5	-0.3	-0.3	-0.3	-0.4	-0.6	-0.6	-0.1		

WIND ANGLE $\theta$ degrees	DISTANCE		
	$h_1$	$h_2$	$h_3$
90	-0.8	-0.6	-0.2
270	Similarly, but handed		

Frictional drag: When wind angle  $\theta = 0^\circ$ , horizontal forces due to frictional drag are allowed for in the above values; and when wind angle  $\theta = 90^\circ$ , allow for frictional drag in accordance with 6.3.1.

NOTE — Evidence on these buildings is fragmentary and any departures from the cases given should be investigated separately.

**TABLE 18 EXTERNAL PRESSURE DISTRIBUTION COEFFICIENTS AROUND CYLINDRICAL STRUCTURES**  
( Clause 6.2.2.8 )

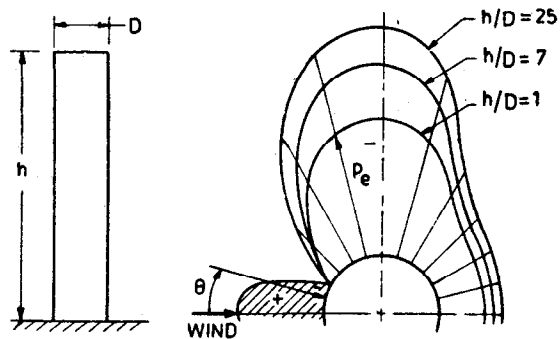

POSITION OF PERIPHERY, $\theta$ IN DEGREES	PRESSURE COEFFICIENT, $C_{pe}$		
	$h/D = 25$	$h/D = 7$	$h/D = 1$
0	1.0	1.0	1.0
15	0.8	0.8	0.8
30	0.1	0.1	0.1
45	-0.9	-0.8	-0.7
60	-1.9	-1.7	-1.2
75	-2.5	-2.2	-1.6
90	-2.6	-2.2	-1.7
105	-1.9	-1.7	-1.2
120	-0.9	-0.8	-0.7
135	-0.7	-0.6	-0.5
150	-0.6	-0.5	-0.4
165	-0.6	-0.5	-0.4
180	-0.6	-0.5	-0.4



**TABLE 19 EXTERNAL PRESSURE COEFFICIENTS FOR ROOFS AND BOTTOMS OF CYLINDRICAL BUILDINGS**

( Clause 6.2.2.9 )

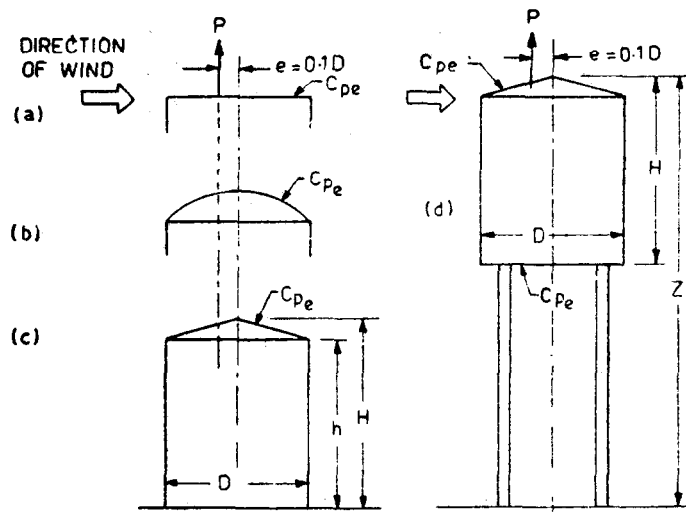

**COEFFICIENT OF EXTERNAL PRESSURE,  $C_{pe}$**

STRUCTURE ACCORDING TO SHAPE				
<i>a, b and c</i>		<i>d</i>		
$H/D$	Roof	$(z/H) - 1$	Roof	Bottom
0.5	-0.65	1.00	-0.75	-0.8
1.00	-1.00	1.25	-0.75	-0.7
2.00	-1.00	1.50	-0.75	-0.6

Total force acting on the roof of the structure,  $P = 0.785 D^2 (p_1 - C_{pe} p_d)$

The resultant of  $P$  lies eccentrically,  $e = 0.1D$

**TABLE 20 EXTERNAL PRESSURE COEFFICIENTS,  $C_{pe}$  FOR COMBINED ROOFS AND ROOFS WITH A SKY LIGHT**  
( Clause 6.2.2.10 )

a) Combined Roofs

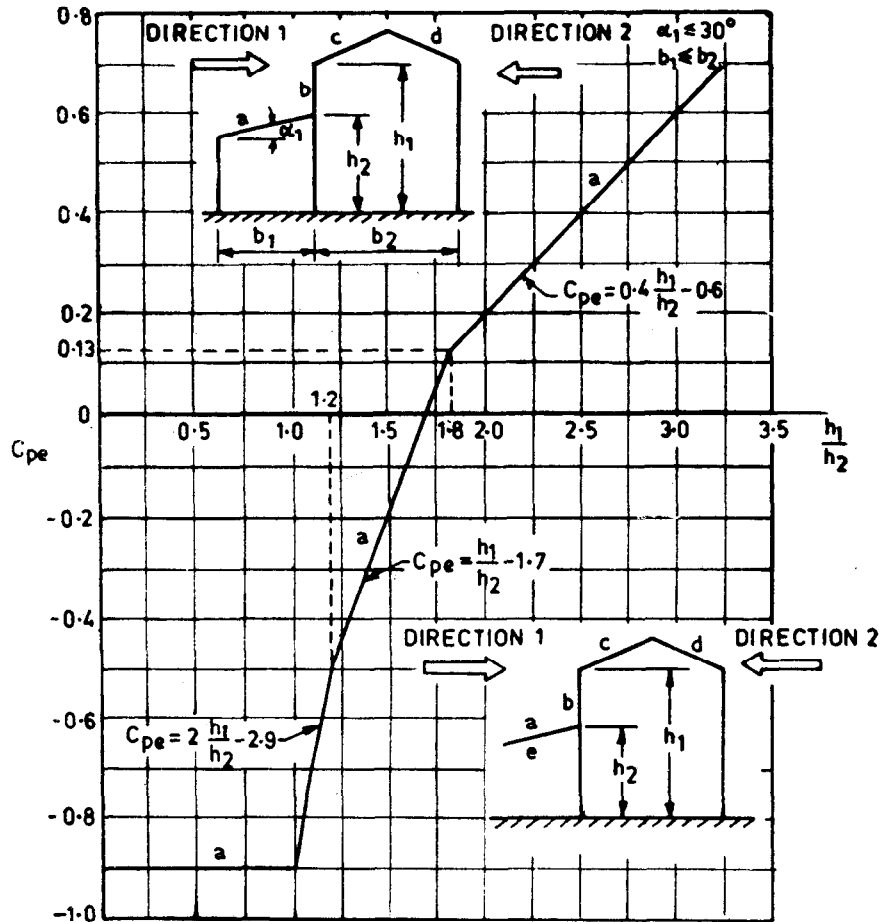

VALUES OF  $C_{pe}$

PORTION	DIRECTION 1	DIRECTION 2
a	From the Diagram	
b	$C_{pe} = -0.5, \frac{h_1}{h_2} \leq 1.5$	-0.4
	$C_{pe} = -0.7, \frac{h_1}{h_2} > 1.5$	
c and d	See Table 5	
e	See 6.2.2.7	

( Continued )

**TABLE 20 EXTERNAL PRESSURE COEFFICIENTS,  $C_{pe}$  FOR COMBINED ROOFS AND ROOFS WITH A SKY LIGHT — Contd**

b) Roofs with a Sky Light

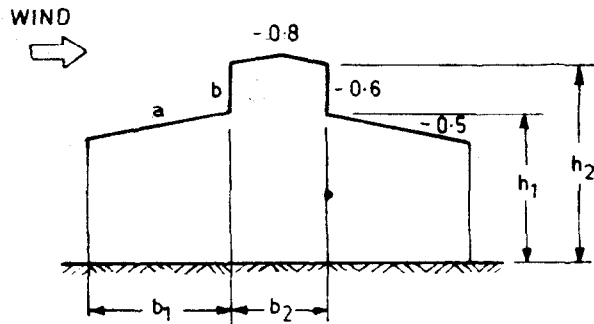
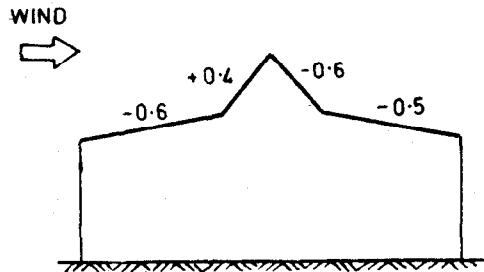

PORTION	$b_1 > b_2$		$b_1 < b_2$
	<i>a</i>	<i>b</i>	<i>a</i> and <i>b</i>
$C_{pe}$	-0.6	+0.7	See Table for combined roofs

**TABLE 21 PRESSURE COEFFICIENTS AT TOP AND BOTTOM ROOF OF GRAND STANDS OPEN THREE SIDES ( ROOF ANGLE UP TO 5° )**

( Clause 6.2.2.11 )

(  $h : b : l = 0.8 : 1 : 2.2$  )

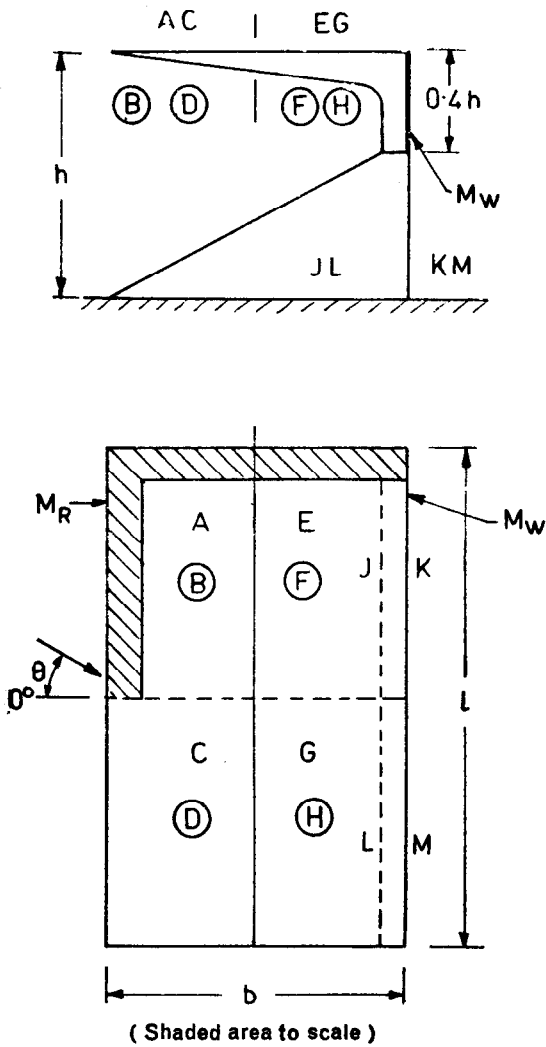

FRONT AND BACK OF WALL

$\theta$	J	K	L	M
0°	+0.9	-0.5	+0.9	-0.5
45°	+0.8	-0.6	+0.4	-0.4
135°	-1.1	+0.6	-1.0	+0.4
180°	-0.3	+0.9	-0.3	+0.9
60°	'M <sub>w</sub> ' - C <sub>P</sub> of K = -1.0			
60°	'M <sub>w</sub> ' - C <sub>P</sub> of J = +1.0			

TOP AND BOTTOM OF ROOF

$\theta$	A	B	C	D	E	F	G	H
0°	-1.0	+0.9	-1.0	+0.9	-0.7	+0.9	+0.7	+0.9
45°	-1.0	+0.7	-0.7	+0.4	-0.5	+0.8	-0.5	+0.3
135°	-0.4	-1.1	-0.7	-1.0	-0.9	-1.1	-0.9	-1.0
180°	-0.6	-0.3	-0.6	-0.3	-0.6	-0.3	-0.6	-0.3
45°	'M <sub>R</sub> ' - C <sub>P</sub> ( top ) = -2.0							
45°	'M <sub>R</sub> ' - C <sub>P</sub> ( bottom ) = +1.0							

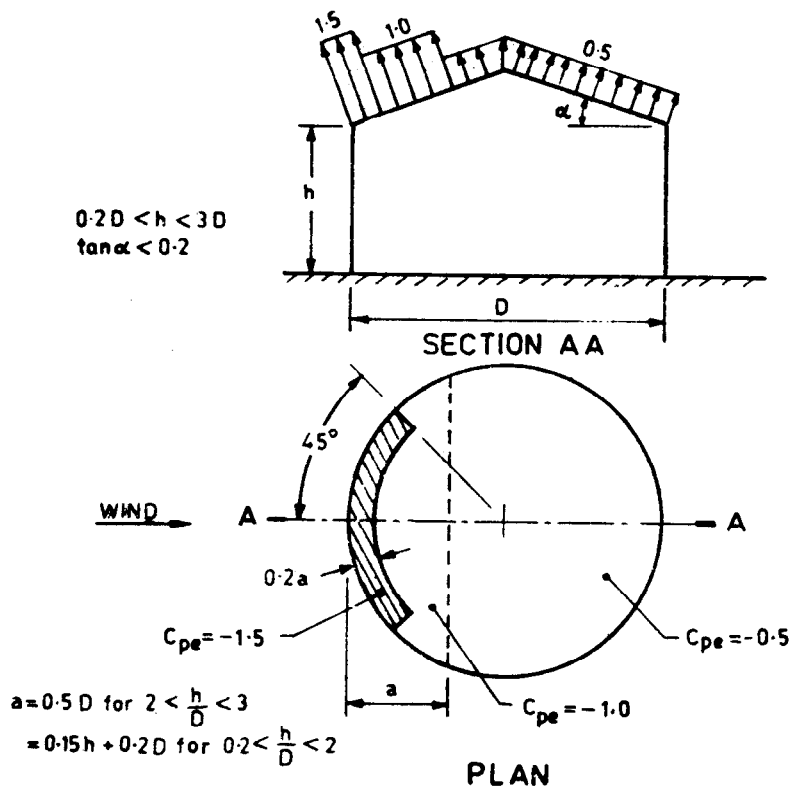

( For Force Coefficient Corresponding to Shell Portion, see Table 23 ).

FIG. 2 EXTERNAL PRESSURE COEFFICIENT ON THE UPPER ROOF SURFACE OF SINGULAR CIRCULAR STANDING ON THE GROUND

**6.2.3.2 Buildings with medium and large openings** — Buildings with medium and large openings may also exhibit either positive or negative internal pressure depending upon the direction of wind. Buildings with medium openings between about 5 to 20 percent of wall area shall be examined for an internal pressure coefficient of +0.5 and later with an internal pressure coefficient of -0.5, and the analysis which produces greater distress of the members shall be adopted. Buildings with large openings, that is, openings larger than 20 percent of the wall area shall be examined once with an internal pressure coefficient of +0.7 and again with an internal pressure coefficient of -0.7, and the analysis which produces greater distress on the members shall be adopted.

Buildings with one open side or opening exceeding 20 percent of wall area may be assumed to be subjected to internal positive pressure or suction similar to those for buildings with large openings. A few examples of buildings with one sided openings are shown in Fig. 3 indicating values of internal pressure coefficients with respect to the direction of wind.

**6.2.3.3** In buildings with roofs but no walls, the roofs will be subjected to pressure from both inside and outside and the recommendations shall be as given in 6.2.2.

**6.3 Force Coefficients** — The value of force coefficients apply to a building or structure as a whole, and when multiplied by the effective frontal area  $A_e$  of the building or structure and by design wind pressure,  $p_d$  gives the total wind load on that particular building or structure.

$$F = C_f A_e p_d$$

where  $F$  is the force acting in a direction specified in the respective tables and  $C_f$  is the force coefficient for the building.

**NOTE 1** — The value of the force coefficient differs for the wind acting on different faces of a building or structure. In order to determine the critical load, the total wind load should be calculated for each wind direction.

**NOTE 2** — If surface design pressure varies with height, the surface area of the building/structure may be sub-divided so that specified pressures are taken over appropriate areas.

**NOTE 3** — In tapered buildings/structures, the force coefficients shall be applied after sub-dividing the building/structure into suitable number of strips and the load on each strip calculated individually, taking the area of each strip as  $A_e$ .

**NOTE 4** — For force coefficients for structures not covered above, reference may be made to specialist literature on the subject or advice may be sought from specialists in the subject.

**TABLE 22 EXTERNAL PRESSURE DISTRIBUTION COEFFICIENTS AROUND SPHERICAL STRUCTURES**

( Clause 6.2.2.13 )

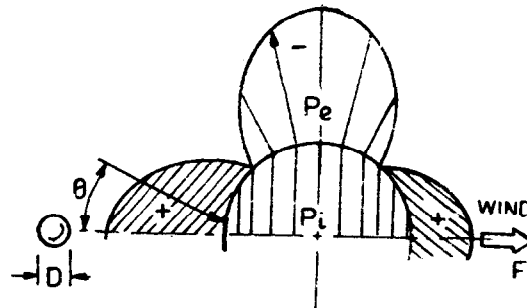

POSITION OF PERIPHERY, $\theta$ IN DEGREES	$C_{pe}$	REMARKS
0	+1.0	$C_t = 0.5$ for $DV_d < 7$
15	+0.9	$= 0.2$ for $DV_d > 7$
30	+0.5	
45	-0.1	
60	-0.7	
75	-1.1	
90	-1.2	
105	-1.0	
120	-0.6	
135	-0.2	
150	+0.1	
165	+0.3	
180	+0.4	

**6.3.1 Frictional Drag** — In certain buildings of special shape, a force due to frictional drag shall be taken into account in addition to those loads specified in 6.2. For rectangular clad buildings, this addition is necessary only where the ratio  $\frac{d}{h}$  or  $\frac{d}{b}$  is greater than 4. The frictional drag force,  $F'$ , in the direction of the wind is given by the following formulae:

$$\text{If } h \leq b, F' = C_f' (d - 4h) b p_d + C_f' (d - 4h) 2 h p_d, \text{ and}$$

$$\text{if } h > b, F' = C_f' (d - 4b) b p_d + C_f' (d - 4b) 2 h p_d.$$

The first term in each case gives the drag on the roof and the second on the walls. The value of  $C_f'$  has the following values:

$C_f' = 0.01$  for smooth surfaces without corrugations or ribs across the wind direction,

$C_f' = 0.02$  for surfaces with corrugations across the wind direction, and

$C_f' = 0.04$  for surfaces with ribs across the wind direction.

For other buildings, the frictional drag has been indicated, where necessary, in the tables of pressure coefficients and force coefficients.

**6.3.2 Force Coefficients for Clad Buildings**

**6.3.2.1 Clad buildings of uniform section —**

The overall force coefficients for rectangular clad buildings of uniform section with flat roofs in uniform flow shall be as given in Fig. 4 and for other clad buildings of uniform section ( without projections, except where otherwise shown ) shall be as given in Table 23.

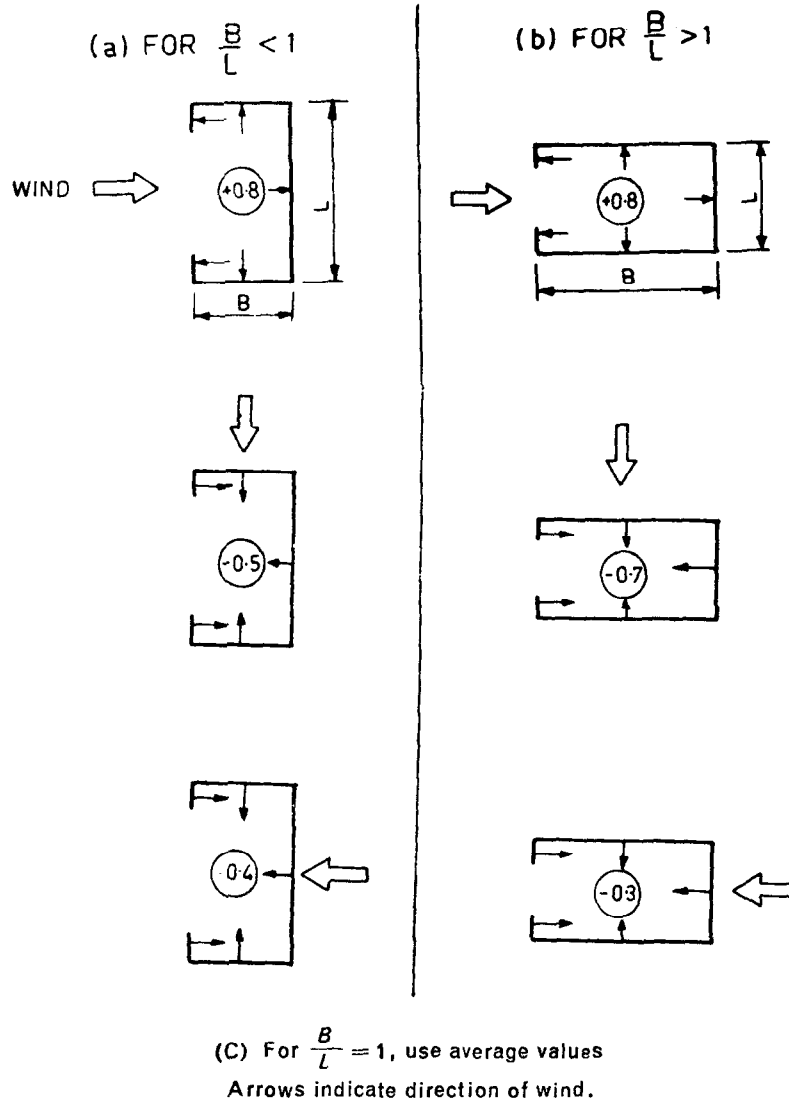

FIG. 3 LARGE OPENING IN BUILDINGS ( VALUES OF COEFFICIENTS OF INTERNAL PRESSURE ) WITH TOP CLOSED

**6.3.2.2 Buildings of circular shapes** — Force coefficients for buildings circular cross-section shapes shall be as given in Table 23. However, more precise estimation of force coefficients for circular shapes of infinite length can be obtained from Fig. 5 taking into account the average height of surface roughness  $\epsilon$ . When the length is finite, the values obtained from Fig. 5 shall be reduced by the multiplication factor  $K$  ( see also Table 25 and Appendix D ).

**6.3.2.3 Low walls and hoardings** — Force coefficients for low walls and hoardings less than 15 m high shall be as given in Table 24 provided the height shall be measured from the ground to the top of the walls or hoarding, and provided that for walls or hoardings above ground the clearance between the wall or hoarding and the ground shall be not less than 0.25 times the vertical dimension of the wall or hoarding.

To allow for oblique winds, the design shall also be checked for net pressure normal to the

surface varying linearly from a maximum of 1.7  $C_f$  at the up wind edge to 0.44  $C_f$  at the down wind edge.

The wind load on appurtenances and supports for hoardings shall be accounted for separately by using the appropriate net pressure coefficients. Allowance shall be made for shielding effects of one element or another.

**6.3.2.4 Solid circular shapes mounted on a surface** — The force coefficients for solid circular shapes mounted on a surface shall be as given in Fig. 6.

**6.3.3 Force Coefficients for Unclad Buildings**

**6.3.3.1 General** — This section applies to permanently unclad buildings and to frameworks of buildings while temporarily unclad. In the case of buildings whose surfaces are well rounded, such as those with elliptic, circular or ovoid cross-sections, the total force can be more at wind speeds much less than the maximum due to

transition in the nature of boundary layer on them. Although this phenomenon is well known in the case of circular cylinders, the same phenomenon exists in the case of many other well-rounded structures, and this possibility must be checked.

6.3.3.2 Individual members

- a) The coefficients refer to the members of infinite length. For members of finite length, the coefficients should be multiplied by a factor  $K$  that depends on the ratio  $l/b$  where  $l$  is the length of the member and  $b$  is the width across the direction of wind. Table 25 gives the required values of  $K$ . The following special cases must be noted while estimating  $K$ .
  - i) Where any member abuts onto a plate or wall in such a way that free flow of air around that end of the member is prevented, then the ratio of  $l/b$  shall be doubled for the purpose of determining  $K$ ; and
  - ii) When both ends of a member are so

obstructed, the ratio  $l/b$  shall be taken as infinity for the purpose of determining  $K$ .

- b) *Flat-sided members* — Force coefficients for wind normal to the longitudinal axis of flat-sided structural members shall be as given in Table 26.

The force coefficients are given for two mutually perpendicular directions relative to a reference axis on the structural member. They are designated as  $C_{fn}$  and  $C_{ft}$ , give the forces normal and transverse, respectively to the reference plane as shown in Table 26.

Normal force,  $F_n = C_{fn} p_d K l b$

Transverse force,  $F_t = C_{ft} p_d K l b$

- c) *Circular sections* — Force coefficients for members of circular section shall be as given in Table 23 ( see also Appendix D ).
- d) Force coefficients for wires and cables shall be as given in Table 27 according to the diameter ( $D$ ), the design wind speed ( $V_d$ ) and the surface roughness.

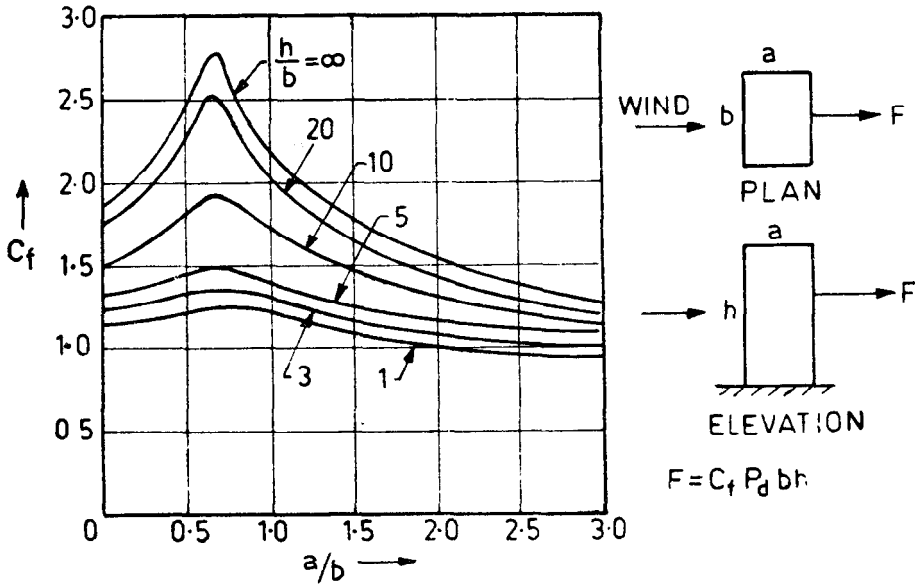

4A Values of  $C_f$  versus  $\frac{a}{b}$  for  $\frac{h}{b} > 1$

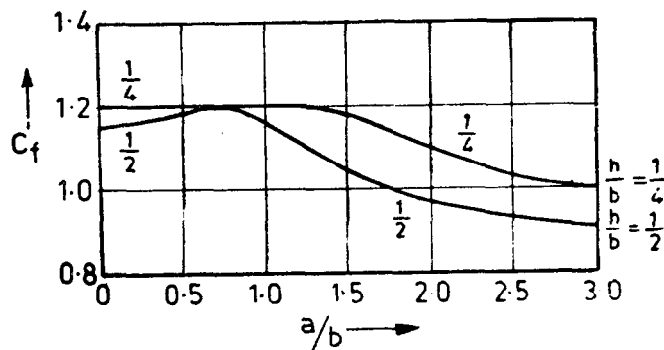

4B Values of  $C_f$  versus  $\frac{a}{b}$  for  $\frac{h}{b} < 1$

FIG. 4 FORCE COEFFICIENTS FOR RECTANGULAR CLAD BUILDINGS IN UNIFORM FLOW



**TABLE 23 FORCE COEFFICIENTS  $C_f$  FOR CLAD BUILDINGS OF UNIFORM SECTION ( ACTING IN THE DIRECTION OF WIND )**

[ Clauses 6.3.2.1, 6.3.2.2 and 6.3.3.2(c) ]

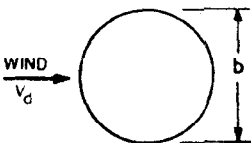
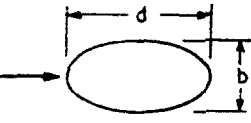
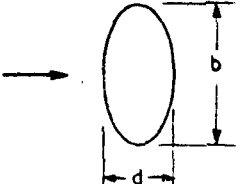
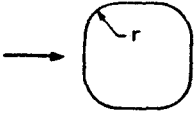
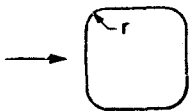
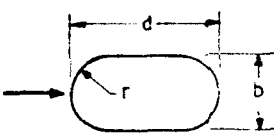
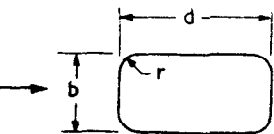
PLAN SHAPE	$V_{db}$ m <sup>2</sup> /s	$C_f$ FOR HEIGHT/BREADTH RATIO							
		Up to 1/2	1	2	5	10	20	$\infty$	
 All surfaces Rough or with projections	< 6	0.7	0.7	0.7	0.8	0.9	1.0	1.2	
	> 6								
See also Appendix C	Smooth	> 6	0.5	0.5	0.5	0.5	0.5	0.6	0.6
 Ellipse $b/d = 1/2$	< 10	0.5	0.5	0.5	0.5	0.6	0.6	0.7	
	> 10	0.2	0.2	0.2	0.2	0.2	0.2	0.2	
 Ellipse $b/d = 2$	< 8	0.8	0.8	0.9	1.0	1.1	1.3	1.7	
	> 8	0.8	0.8	0.9	1.0	1.1	1.3	1.5	
 $b/d = 1$ $r/b = 1/3$	< 4	0.6	0.6	0.6	0.7	0.8	0.8	1.0	
	> 4	0.4	0.4	0.4	0.4	0.5	0.5	0.5	
 $b/d = 1$ $r/b = 1/6$	< 10	0.7	0.8	0.8	0.9	1.0	1.0	1.3	
	> 10	0.5	0.5	0.5	0.5	0.6	0.6	0.6	
 $b/d = 1/2$ $r/b = 1/2$	< 3	0.3	0.3	0.3	0.3	0.3	0.3	0.4	
	> 3	0.2	0.2	0.2	0.2	0.3	0.3	0.3	
 $b/d = 1/2$ $r/b = 1/6$	All values	0.5	0.5	0.5	0.5	0.6	0.6	0.7	
	All values	0.9	0.9	1.0	1.1	1.2	1.5	1.9	

( Continued )

**TABLE 23 FORCE COEFFICIENTS  $C_f$  FOR CLAD BUILDINGS OF UNIFORM SECTION  
( ACTING IN THE DIRECTION OF WIND ) — Contd**

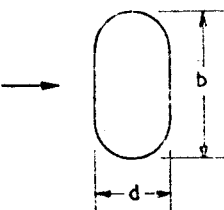
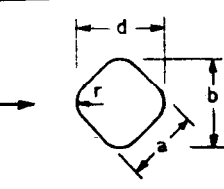
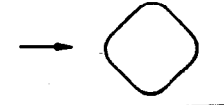
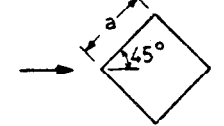
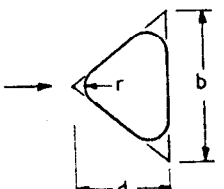
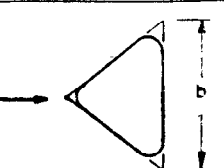
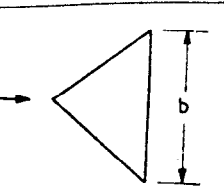
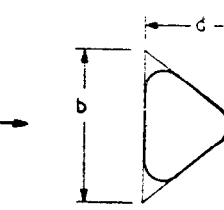
PLAN SHAPE	$V_{db}$ m <sup>2</sup> /s	$C_f$ FOR HEIGHT/BREADTH RATIO						
		Up to 1/2	1	2	5	10	20	$\infty$
 $b/d = 2$ $r/b = 1/4$	$< 6$	0.7	0.8	0.8	0.9	1.0	1.2	1.6
	$> 6$	0.5	0.5	0.5	0.5	0.5	0.6	0.6
 $r/a = 1/3$	$< 10$	0.8	0.8	0.9	1.0	1.1	1.3	1.5
	$> 10$	0.5	0.5	0.5	0.5	0.5	0.6	0.6
 $r/a = 1/12$ All values	All values	0.9	0.9	0.9	1.1	1.2	1.3	1.6
 $r/a = 1/48$ All values	All values	0.9	0.9	0.9	1.1	1.2	1.3	1.6
 $r/b = 1/4$	$< 11$	0.7	0.7	0.7	0.8	0.9	1.0	1.2
	$> 11$	0.4	0.4	0.4	0.4	0.5	0.5	0.5
 $r/b = 1/12$ All values	All values	0.8	0.8	0.8	1.0	1.1	1.2	1.4
 $r/b = 1/48$ All values	All values	0.7	0.7	0.8	0.9	1.0	1.1	1.3
 $r/b = 1/4$	$< 8$	0.7	0.7	0.8	0.9	1.0	1.1	1.3
	$> 8$	0.4	0.4	0.4	0.4	0.5	0.5	0.5

( Continued )

**TABLE 23 FORCE COEFFICIENTS  $C_f$  FOR CLAD BUILDINGS OF UNIFORM SECTION ( ACTING IN THE DIRECTION OF WIND ) — Contd**

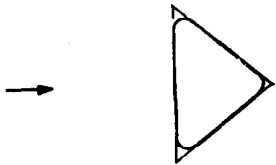
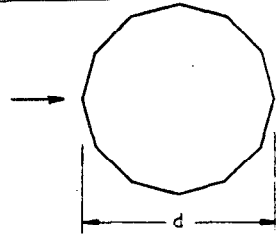
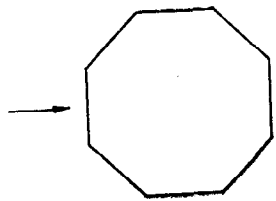
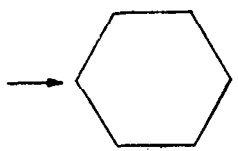
PLAN SHAPE	$V_{db}$ m <sup>2</sup> /s	$C_f$ FOR HEIGHT/BREADTH RATIO						
		Up to 1/2	1	2	5	10	20	$\infty$
 $1/48 < r/b < 1/12$ All values		1.2	1.2	1.2	1.4	1.6	1.7	2.1
 12-sided polygon $d$	$< 12$	0.7	0.7	0.8	0.9	1.0	1.1	1.3
	$\geq 12$	0.7	0.7	0.7	0.7	0.8	0.9	1.1
 Octagon All values		1.0	1.0	1.1	1.2	1.2	1.3	1.4
 Hexagan All values		1.0	1.1	1.2	1.3	1.4	1.4	1.5

Structures that, because of their size and design wind velocity, are in the supercritical flow regime may need further calculation to ensure that the greatest loads do not occur at some wind speed below the maximum when the flow will be subcritical.

The coefficients are for buildings without projections, except where otherwise shown.

In this table  $V_{db}$  is used as an indication of the airflow regime.

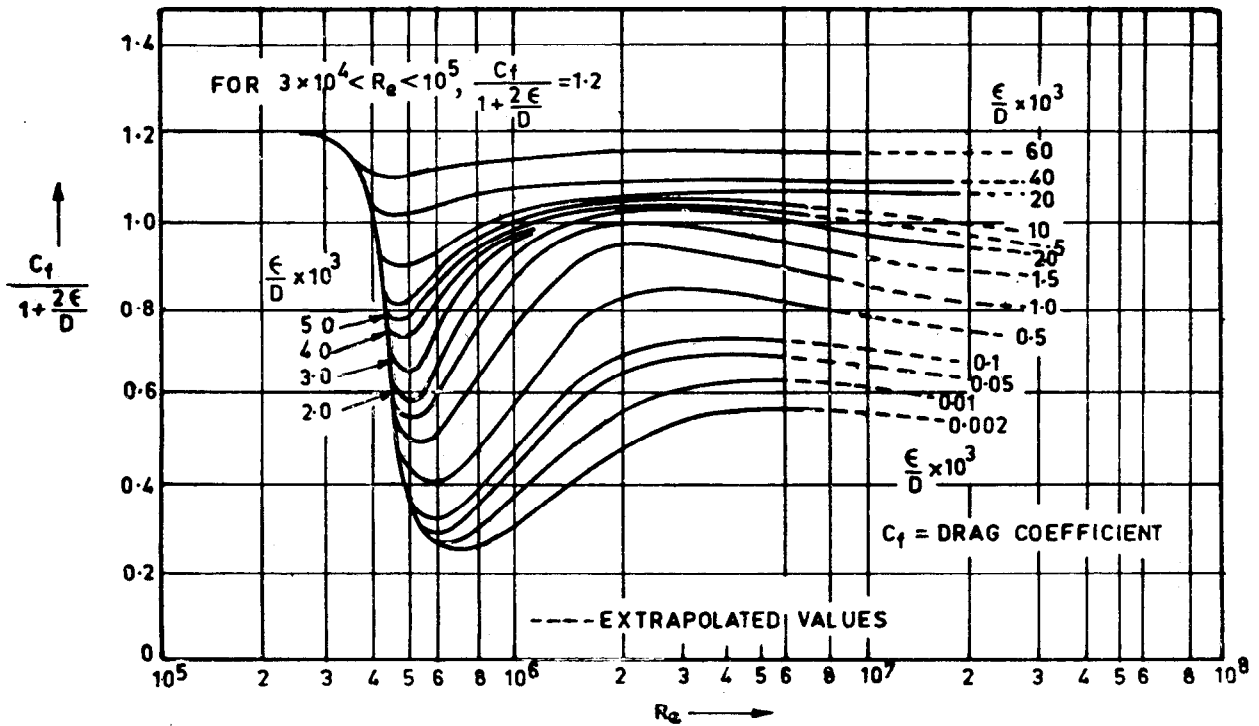
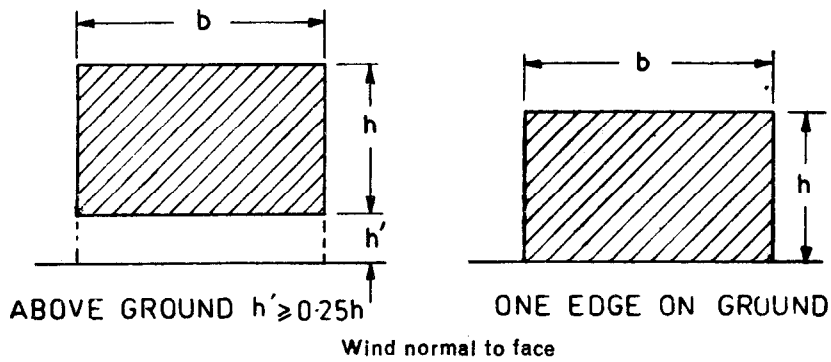

FIG. 5 VARIATION OF  $\frac{C_f}{1 + \frac{2\epsilon}{D}}$  WITH  $Re$  ( $> 3 \times 10^4$ ) FOR CIRCULAR SECTIONS

TABLE 24 FORCE COEFFICIENTS FOR LOW WALLS OR HOARDINGS ( $< 15\text{m}$  HIGH)  
( Clause 6.3.2.3 )



WIDTH TO HEIGHT RATIO, $b/h$		DRAG COEFFICIENT, $C_f$
Wall Above Ground	Wall on Ground	
From 0.5 to 6	From 1 to 12	1.2
10	20	1.3
16	32	1.4
20	40	1.5
40	80	1.75
60	120	1.8
80 or more	160 or more	2.0

SIDE ELEVATION	DESCRIPTION OF SHAPE	$C_f$
	CIRCULAR DISC	1.2
	HEMISPHERICAL BOWL	1.4
	HEMISPHERICAL BOWL	0.4
	HEMISPHERICAL SOLID	1.2
	SPHERICAL SOLID	0.5 FOR $V_d D < 7$ 0.2 FOR $V_d D \geq 7$

FIG. 6 FORCE COEFFICIENTS FOR SOLID SHAPES MOUNTED ON A SURFACE

TABLE 25 REDUCTION FACTOR  $K$  FOR INDIVIDUAL MEMBERS

[ Clauses 6.3.2.2 and 6.3.3.2(a) ]

$l/b$ or $l/D$	2	5	10	20	40	50	100	$\infty$
Circular cylinder, subcritical flow	0.58	0.62	0.68	0.74	0.82	0.87	0.98	1.00
Circular cylinder, supercritical flow ( $DV_d \geq 6m^2/s$ )	0.80	0.80	0.82	0.90	0.98	0.99	1.00	1.00
Flat plate perpendicular to wind ( $DV_d \geq 6m^2/s$ )	0.62	0.66	0.69	0.81	0.87	0.90	0.95	1.00

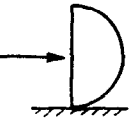
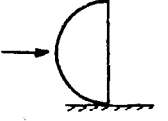
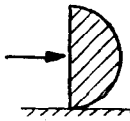
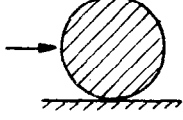
**TABLE 26 FORCE COEFFICIENTS ( $C_f$ ) FOR INDIVIDUAL STRUCTURAL MEMBERS OF INFINITE LENGTH**

[ Clause 6.3.3.2(b) ]

Diagram		Diagram		Diagram		Diagram		Diagram		Diagram		
0	$C_{fn}$ $C_{ft}$	$C_{fn}$ $C_{ft}$	$C_{fn}$ $C_{ft}$	$C_{fn}$ $C_{ft}$	$C_{fn}$ $C_{ft}$	$C_{fn}$ $C_{ft}$	$C_{fn}$ $C_{ft}$	$C_{fn}$ $C_{ft}$	$C_{fn}$ $C_{ft}$	$C_{fn}$ $C_{ft}$		
degrees												
0	+1.9 +0.95	+1.8 +1.8	+1.75 +0.1	+1.6 0	+2.0 0	+2.05 0	+1.8 +0.8	+2.1 +1.8	+0.85 +0.85	+1.5 -0.1	+1.2 +0.9	+1.85 +0.6
45	+1.8 +0.8	+2.1 +1.8	+0.85 +0.85	+1.5 -0.1	+1.2 +0.9	+1.85 +0.6	+2.0 +1.7	-1.9 -1.0	+0.1 +1.75	-0.95 +0.7	-1.6 +2.15	0 +0.6
90	+2.0 +1.7	-1.9 -1.0	+0.1 +1.75	-0.95 +0.7	-1.6 +2.15	0 +0.6	-1.8 -0.1	-2.0 +0.3	-0.75 +0.75	-0.5 +1.05	-1.1 +2.4	-1.6 +0.4
135	-1.8 -0.1	-2.0 +0.3	-0.75 +0.75	-0.5 +1.05	-1.1 +2.4	-1.6 +0.4	-2.0 +0.1	-1.4 -1.4	-1.75 -0.1	-1.5 0	-1.7 ±2.1	-1.8 0
180	-2.0 +0.1	-1.4 -1.4	-1.75 -0.1	-1.5 0	-1.7 ±2.1	-1.8 0						
0	$C_{fn}$ $C_{ft}$	$C_{fn}$ $C_{ft}$	$C_{fn}$ $C_{ft}$	$C_{fn}$ $C_{ft}$	$C_{fn}$ $C_{ft}$	$C_{fn}$ $C_{ft}$	$C_{fn}$ $C_{ft}$	$C_{fn}$ $C_{ft}$	$C_{fn}$ $C_{ft}$	$C_{fn}$ $C_{ft}$		
degrees												
0	+1.4 0	+2.05 0	+1.6 0	+2.0 0	+2.0 0	+2.05 0	+1.2 +1.6	+1.95 +0.6	+1.5 +1.5	+1.8 +0.1	+1.55 +1.55	0 +2.0
45	+1.2 +1.6	+1.95 +0.6	+1.5 +1.5	+1.8 +0.1	+1.55 +1.55	0 +2.0	0 +2.2	+0.5 +0.9	0 +1.9	0 +0.1	0 +2.0	
90	0 +2.2	+0.5 +0.9	0 +1.9	0 +0.1	0 +2.0							

NOTE — In this table, the force coefficient  $C_f$  is given in relation to the dimension  $b$  and not, as in other cases, in relation to effective frontal area  $A_e$ .

**TABLE 27 FORCE COEFFICIENTS FOR WIRES AND CABLES ( $l/D = 100$ )**

[ Clause 6.3.3.2(d) ]

FLOW REGIME	FORCE COEFFICIENT, $C_f$ FOR			
	Smooth Surface	Moderately Smooth Wire (Galvanized or Painted)	Fine Stranded Cables	Thick Stranded Cables
(1)	(2)	(3)	(4)	(5)
$DV_d < 0.6 \text{ m}^2/\text{s}$	—	—	1.2	1.3
$DV_d \geq 0.6 \text{ m}^2/\text{s}$	—	—	0.9	1.1
$DV_d < 0.6 \text{ m}^2/\text{s}$	1.2	1.2	—	—
$DV_d \geq 0.6 \text{ m}^2/\text{s}$	0.5	0.7	—	—

**6.3.3.3 Single frames** — Force coefficients for a single frame having either:

- a) all flat sided members, or
- b) all circular members in which all the members of the frame have either:
  - i)  $DV_d$  less than  $6 \text{ m}^2/\text{s}$ , or
  - ii)  $DV_d$  greater than  $6 \text{ m}^2/\text{s}$ .

shall be as given in Table 28 according to the type of the member, the diameter ( $D$ ), the design wind speed ( $V_d$ ) and the solidity ratio ( $\phi$ ).

**TABLE 28 FORCE COEFFICIENTS FOR SINGLE FRAMES**

SOLIDITY RATIO $\phi$	FORCE COEFFICIENTS, $C_f$ , FOR		
	Flat-sided Members	Circular Sections	
		Subcritical flow ( $DV_d < 6 \text{ m}^2/\text{s}$ )	Supercritical flow ( $DV_d \geq 6 \text{ m}^2/\text{s}$ )
(1)	(2)	(3)	(4)
0.1	1.9	1.2	0.7
0.2	1.0	1.2	0.8
0.3	1.7	1.2	0.8
0.4	1.7	1.1	0.8
0.5	1.6	1.1	0.8
0.75	1.6	1.5	1.4
1.00	2.0	2.0	2.0

Linear interpolation between the values is permitted.

Force coefficients for a single frame not complying with the above requirements shall be calculated as follows:

$$C_f = \gamma C_{f \text{ super}} + (1 - \gamma) \frac{A_{\text{circ sub}}}{A_{\text{sub}}} C_{f \text{ sub}} + (1 - \gamma) \frac{A_{\text{flat}}}{A_{\text{sub}}} C_{f \text{ flat}}$$

where

$C_{f \text{ super}}$  = force coefficient for the supercritical circular members as given in Table 28 or Appendix D,

$C_{f \text{ sub}}$  = force coefficient for subcritical circular members as given in Table 28 or Appendix D,

$C_{f \text{ flat}}$  = force coefficient for the flat sided members as given in Table 28,

$A_{\text{circ sub}}$  = effective area of subcritical circular members,

$A_{\text{flat}}$  = effective area of flat-sided members,

$A_{\text{sub}} = A_{\text{circ sub}} + A_{\text{flat}}$ , and

$$\gamma = \left( \frac{\text{Area of the frame in a supercritical flow}}{A_e} \right)$$

**6.3.3.4 Multiple frame buildings** — This section applies to structures having two or more parallel frames where the windward frames may have a shielding effect upon the frames to leeward side. The windward frame and any unshielded parts of other frames shall be calculated in accordance with 6.3.3.3, but the wind load on the parts of frames that are sheltered should be multiplied by a shielding factor which is dependent upon the solidity ratio of the windward frame, the types of the members comprising the frame and the spacing ratio of the frames. The values of the shielding factors are given in Table 29.

**TABLE 29 SHIELDING FACTOR  $\eta$  FOR MULTIPLE FRAMES**

EFFECTIVE SOLIDITY RATIO, $\beta$	FRAME SPACING RATIO				
	<0.5	1.0	2.0	4.0	>8.0
(1)	(2)	(3)	(4)	(5)	(6)
0	1.0	1.0	1.0	1.0	1.0
0.1	0.9	1.0	1.0	1.0	1.0
0.2	0.8	0.9	1.0	1.0	1.0
0.3	0.7	0.8	1.0	1.0	1.0
0.4	0.6	0.7	1.0	1.0	1.0
0.5	0.5	0.6	0.9	1.0	1.0
0.7	0.3	0.6	0.8	0.9	1.0
1.0	0.3	0.6	0.6	0.8	1.0

Linear interpolation between values is permitted.

Where there are more than two frames of similar geometry and spacing, the wind load on the third and subsequent frames should be taken as equal to that on the second frame. The loads on the various frames shall be added to obtain total load on the structure.

- a) The frame spacing ratio is equal to the distance, centre to centre of the frames, beams or girders divided by the least overall dimension of the frame, beam or girder measured at right angles to the direction of the wind. For triangular framed structures or rectangular framed structures diagonal to the wind, the spacing ratio

should be calculated from the mean distance between the frames in the direction of the wind.

b) Effective solidity ratio,  $\beta$ :

$\beta = \phi$  for flat-sided members.

$\beta$  is to be obtained from Fig. 7 for members of circular cross-sections.

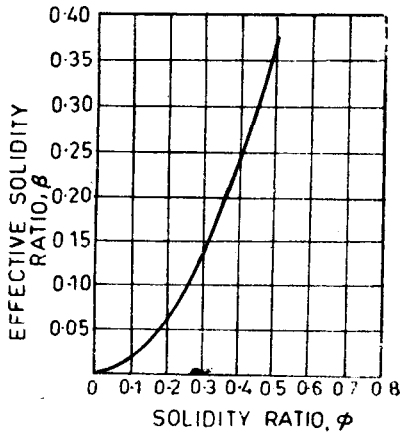

FIG. 7 EFFECTIVE SOLIDITY RATIO,  $\beta$  FOR ROUND SECTION MEMBERS

6.3.3.5 Lattice towers

a) Force coefficient for lattice towers of square or equilateral triangle section with flat-sided members for wind blowing against any face shall be as given in Table 30.

TABLE 30 OVERALL FORCE COEFFICIENT FOR TOWERS COMPOSED OF FLAT-SIDED MEMBERS

SOLIDITY RATIO $\phi$	FORCE COEFFICIENT FOR	
	Square Towers	Equilateral Triangular Towers
(1)	(2)	(3)
0.1	3.8	3.1
0.2	3.3	2.7
0.3	2.8	2.3
0.4	2.3	1.9
0.5	2.1	1.5

- b) For square lattice towers with flat-sided members the maximum load, which occurs when the wind blows into a corner shall be taken as 1.2 times the load for the wind blowing against a face.
- c) For equilateral-triangle lattice towers with flat-sided members, the load may be assumed to be constant for any inclination of wind to a face.
- d) Force coefficients for lattice towers of square section with circular members, all in the same flow regime, may be as given in Table 31.

e) Force coefficients for lattice towers of equilateral-triangle section with circular members all in the same flow regime may be as given in Table 32.

TABLE 31 OVERALL FORCE COEFFICIENT FOR SQUARE TOWERS COMPOSED OF ROUNDED MEMBERS

[ Clause 6.3.3.5(d) ]

SOLIDITY RATIO OF FRONT FACE	FORCE COEFFICIENT FOR			
	Subcritical Flow ( $DV_d < 6 \text{ m}^2/\text{s}$ )		Supercritical Flow ( $DV_d \geq 6 \text{ m}^2/\text{s}$ )	
	Onto face	Onto corner	Onto face	Onto corner
(1)	(2)	(3)	(4)	(5)
0.05	2.4	2.5	1.1	1.2
0.1	2.2	2.3	1.2	1.3
0.2	1.9	2.1	1.3	1.6
0.3	1.7	1.9	1.4	1.6
0.4	1.6	1.9	1.4	1.6
0.5	1.4	1.9	1.4	1.6

TABLE 32 OVERALL FORCE COEFFICIENT FOR EQUILATERAL-TRIANGULAR TOWERS COMPOSED OF ROUNDED MEMBERS

[ Clause 6.3.3.5(e) ]

SOLIDITY RATIO OF FRONT FACE $\phi$	FORCE COEFFICIENT FOR	
	Subcritical Flow ( $DV_d < 6 \text{ m}^2/\text{s}$ )	Supercritical Flow ( $DV_d \geq 6 \text{ m}^2/\text{s}$ )
(1)	(2)	(3)
0.05	1.8	0.8
0.1	1.7	0.8
0.2	1.6	1.1
0.3	1.5	1.1
0.4	1.5	1.1
0.5	1.4	1.2

6.3.3.6 Tower appurtenances — The wind loading on tower appurtenances, such as ladders, conduits, lights, elevators, etc, shall be calculated using appropriate net pressure coefficients for these elements. Allowance may be made for shielding effect from other elements.

7. DYNAMIC EFFECTS

7.1 General — Flexible slender structures and structural elements shall be investigated to ascertain the importance of wind induced oscillations or excitations along and across the direction of wind.

In general, the following guidelines may be used for examining the problems of wind induced oscillations:

- a) Buildings and closed structures with a height to minimum lateral dimension ratio of more than about 5.0, and



- b) Buildings and closed structures whose natural frequency in the first mode is less than 1.0 Hz.

Any building or structure which does not satisfy either of the above two criteria shall be examined for dynamic effects of wind.

NOTE 1 — The fundamental time period ( $T$ ) may either be established by experimental observations on similar buildings or calculated by any rational method of analysis. In the absence of such data,  $T$  may be determined as follows for multi-storeyed buildings:

- a) For moment resisting frames without bracing or shear walls for resisting the lateral loads

$$T = 0.1 n$$

where

$n$  = number of storeys including basement storeys; and

- b) For all others

$$T = \frac{0.09 H}{\sqrt{d}}$$

where

$H$  = total height of the main structure of the building in metres, and

$d$  = maximum base dimension of building in metres in a direction parallel to the applied wind force.

NOTE 2 — If preliminary studies indicate that wind-induced oscillations are likely to be significant, investigations should be persuaded with the aid of analytical methods or, if necessary, by means of wind tunnel tests on models.

NOTE 3 — Cross-wind motions may be due to lateral gustiness of the wind, unsteady wake flow (for example, vortex shedding), negative aerodynamic damping or to a combination of these effects. These cross-wind motions can become critical in the design of tall buildings/structures.

NOTE 4 — Motions in the direction of wind (known also as buffeting) are caused by fluctuating wind force associated with gusts. The excitations depend on gust energy available at the resonant frequency.

NOTE 5 — The wake shed from an upstream body may intensify motions in the direction of the wind, and may also affect crosswind motions.

NOTE 6 — The designer must be aware of the following three forms of wind induced motion which are characterized by increasing amplitude of oscillation with the increase of wind speed.

- a) *Galloping* — Galloping is transverse oscillations of some structures due to the development of aerodynamic forces which are in phase with the motion. It is characterized by the progressively increasing amplitude of transverse vibration with increase of wind speed. The cross-section which are particularly prone to this type of excitation include the following:

- i) All structures with non-circular cross-sections, such as triangular, square, polygons, as well as angles, crosses, and T-sections.

- ii) Twisted cables and cables with ice encrustations.

- b) *Flutter* — Flutter is unstable oscillatory motion of a structure due to coupling between aerodynamic force and elastic deformation of the structure. Perhaps the most common form is oscillatory motion due to combined bending and torsion. Although oscillatory motions in each degree of freedom may be damped, instability can set in due to energy transfer from one mode of oscillation to another, and the structure is seen to execute sustained or divergent oscillations

with a type of motion which is a combination of the individual modes of motion. Such energy transfer takes place when the natural frequencies of modes, taken individually, are close to each other (ratio being typically less than 2.0). Flutter can set in at wind speeds much less than those required for exciting the individual modes of motion. Long span suspension bridge decks or any member of a structure with large values of  $d/t$  (where  $d$  is the depth of a structure or structural member parallel to wind stream and  $t$  is the least lateral dimension of a member) are prone to low speed flutter. Wind tunnel testing is required to determine critical flutter speeds and the likely structural response. Other types of flutter are single degree of freedom stall flutter, torsional flutter, etc.

- c) *Ovalling* — This walled structures with open ends at one or both ends such as oil storage tanks, and natural draught cooling towers in which the ratio of the diameter of minimum lateral dimension to the wall thickness is of the order of 100 or more, are prone to ovalling oscillations. These oscillations are characterized by periodic radial deformation of the hollow structure.

NOTE 7 — Buildings and structures that may be subjected to serious wind excited oscillations require careful investigation. It is to be noted that wind induced oscillations may occur at wind speeds lower than the static design wind speed for the location.

NOTE 8 — Analytical methods for the response of dynamic structures to wind loading can be found in the following publications:

- i) Engineering Science Data, Wind Engineering Sub-Series (4 volumes), London, ESDU International.
- ii) 'Wind Engineering in the Eighties', Construction Industry Research and Information Association, 1981, London.
- iii) 'Wind Effects on Structures' by E. Simiu and R.H. Scanlan, New York, John Wiley and Sons, 1978.
- iv) Supplement to the National Building Code of Canada, 1980, NRCC, No. 17724, Ottawa, National Research Council of Canada, 1980.
- v) Wind forces on structures by Peter Sachs. Pergamon press.
- vi) Flow induced vibration by Robert D. Clewins, Von Nostrand Reinhold Co.
- vii) Appropriate Indian Standards (see 1.1.3).

NOTE 9 — In assessing wind loads due to such dynamic phenomenon as galloping, flutter and ovalling, if the required information is not available either in the references of Note 8 or other literature, specialist advice shall be sought, including experiments on models in wind tunnels.

## 7.2 Motion Due to Vortex Shedding

7.2.1 *Slender Structures* — For a structure, the shedding frequency,  $\eta$  shall be determined by the following formula:

$$\eta = \frac{SV_d}{b}$$

where

$S$  = Strouhal number,

$V_d$  = design wind velocity, and

$b$  = breadth of a structure or structural members in the horizontal plane normal to the wind direction.

a) *Circular Structures* — For structures circular in cross-section:

$$S = 0.20 \text{ for } bV_z \text{ not greater than } 7, \text{ and}$$

$$= 0.25 \text{ for } bV_z \text{ greater than } 7.$$

b) *Rectangular Structures* — For structures of rectangular cross-section:

$$S = 0.15 \text{ for all values of } bV_z.$$

NOTE 1 — Significant cross wind motions may be produced by vortex shedding if the natural frequency of the structure or structural element is equal to the frequency of the vortex shedding within the range of expected wind velocities. In such cases, further analysis should be carried out on the basis of references given in Note 8 of 7.1.

NOTE 2 — Unlined welded steel chimney stacks and similar structures are prone to excitation by vortex shedding.

NOTE 3 — Intensification of the effects of periodic vortex shedding has been reported in cases where two or more similar structures are located in close proximity, for example, at less than 20 *b* apart, where *b* is the dimension of the structure normal to the wind.

NOTE 4 — The formulae given in 7.2.1(a) and (b) are valid for infinitely long cylindrical structures. The value of *S* decreases slowly as the ratio of length to maximum transverse width decreases; the reduction being up to about half the value, if the structure is only three times higher than its width. Vortex shedding need not be considered if the ratio of length to maximum transverse width is less than 2.0.

### 8. GUST FACTOR ( *GF* ) OR GUST EFFECTIVENESS FACTOR ( *GEF* ) METHOD

**8.1 Application** — Only the method of calculating load along wind or drag load by using gust factor method is given in the code since methods for calculating load across-wind or other components are not fully matured for all types of structures. However, it is permissible for a designer to use gust factor method to calculate all components of load on a structure using any available theory. However, such a theory must take into account the random nature of atmospheric wind speed.

NOTE — It may be noted that investigations for various types of wind induced oscillations outlined in 7 are in no way related to the use of gust factor method given in 8 although the study of 7 is needed for using gust factor method.

**8.2 Hourly Mean Wind** — Use of the existing theories of gust factor method require a knowledge of maximum wind speeds averaged over one hour at a particular location. Hourly mean wind speeds at different heights in different terrains is given in Table 33.

NOTE — It must also be recognized that the ratio of hourly mean wind ( HMW ) to peak speed given in Table 33 may not be obtainable in India since extreme wind occurs mainly due to cyclones and thunderstorms, unlike in UK and Canada where the mechanism is fully developed pressure system. However Table 33 may be followed at present for the estimation of the hourly mean wind speed till more reliable values become available.

**8.2.1 Variation of Hourly Mean Wind Speed with Height** — The variation of hourly mean wind speed with height shall be calculated as follows:

$$\bar{V}_z = V_b k_1 k_2 k_3$$

where

$\bar{V}_z$  = hourly mean wind speed in m/s, at height *z*;

$V_b$  = regional basic wind speed in m/s ( see Fig. 1 );

$k_1$  = probability factor ( see 5.3.1 );

$k_2$  = terrain and height factor ( see Table 33 ); and

$k_3$  = topography factor ( see 5.3.3 ).

**TABLE 33 HOURLY MEAN WIND SPEED FACTOR  $k_2$  IN DIFFERENT TERRAINS FOR DIFFERENT HEIGHTS**  
( Clauses 8.2 and 8.2.1 )

HEIGHT m	TERRAIN			
	Category 1	Category 2	Category 3	Category 4
(1)	(2)	(3)	(4)	(5)
Up to 10	0.78	0.67	0.50	0.24
15	0.82	0.72	0.55	0.24
20	0.85	0.75	0.59	0.24
30	0.88	0.79	0.64	0.34
50	0.93	0.85	0.70	0.45
100	0.99	0.92	0.79	0.57
150	1.03	0.96	0.84	0.64
200	1.06	1.00	0.88	0.68
250	1.08	1.02	0.91	0.72
300	1.09	1.04	0.93	0.74
350	1.11	1.06	0.95	0.77
400	1.12	1.07	0.97	0.79
450	1.13	1.08	0.98	0.81
500	1.14	1.09	0.99	0.82

**8.3 Along Wind Load** — Along wind load on a structure on a strip area (  $A_e$  ) at any height ( *z* ) is given by:

$$F_z = C_f A_e \bar{p}_z G$$

where

$F_z$  = along wind load on the structure at any height *z* corresponding to strip area  $A_e$ ,

$C_f$  = force coefficient for the building,

$A_e$  = effective frontal area considered for the structure at height *z*,

$\bar{p}_z$  = design pressure at height *z* due to hourly mean wind obtained as  $0.6 \bar{V}_z^2$  ( N/m<sup>2</sup> ),

$G$  = gust factor ( =  $\frac{\text{peak load}}{\text{mean load}}$  ), and is given by:

$$G = 1 + g_f r \sqrt{ \left[ B (1 + \phi)^2 + \frac{SE}{\beta} \right]}$$

where

$g_r$  = peak factor defined as the ratio of the expected peak value to the root mean value of a fluctuating load, and

$r$  = roughness factor which is dependent on the size of the structure in relation to the ground roughness.

The value of ' $g_r$ ' is given in Fig. 8,

$B$  = background factor indicating a measure of slowly varying component of fluctuating wind load and is obtained from Fig. 9,

$\frac{SE}{\beta}$  = measure of the resonant component of the fluctuating wind load,

$S$  = size reduction factor ( see Fig. 10 ),

$E$  = measure of available energy in the wind stream at the natural frequency of the structure ( see Fig. 11 ),

$\beta$  = damping coefficient ( as a fraction of critical damping ) of the structure ( see Table 34 ), and

$\phi = \frac{g_r r \sqrt{B}}{4}$  and is to be accounted only for buildings less than 75 m high in terrain Category 4 and for buildings less than 25 m high in terrain Category 3, and is to be taken as zero in all other cases.

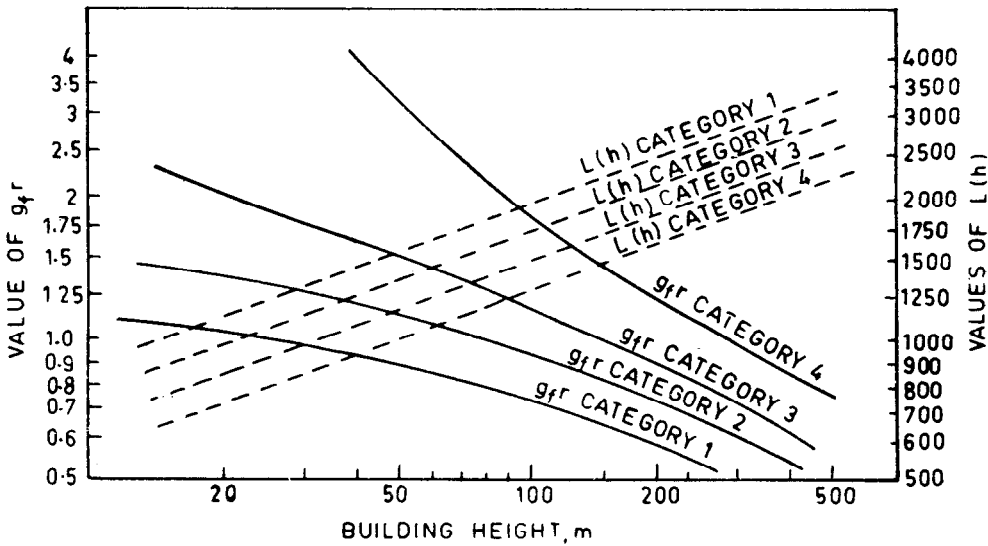

FIG. 8 VALUES OF  $g_r r$  AND  $L(h)$

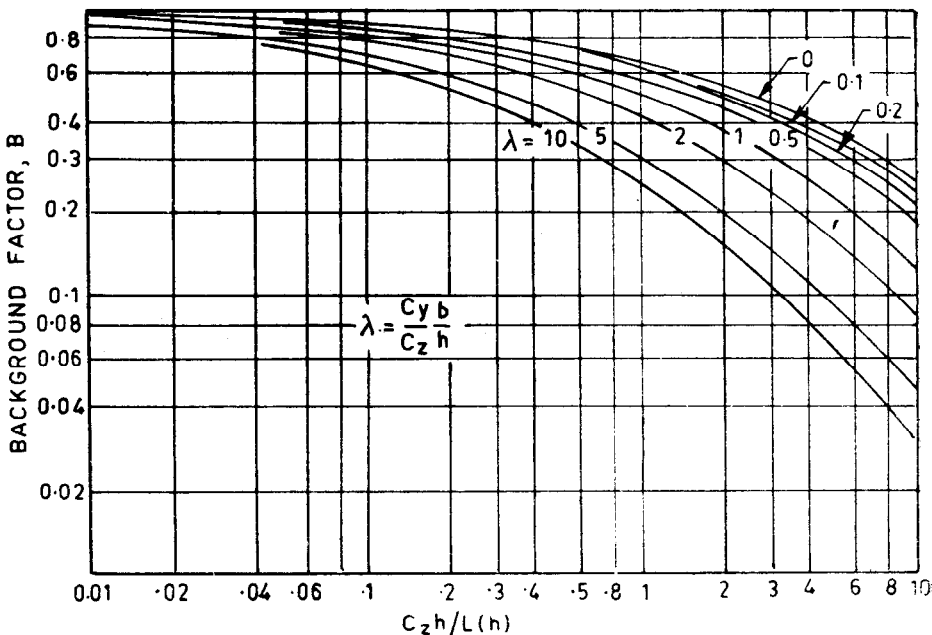

FIG. 9 BACKGROUND FACTOR  $B$

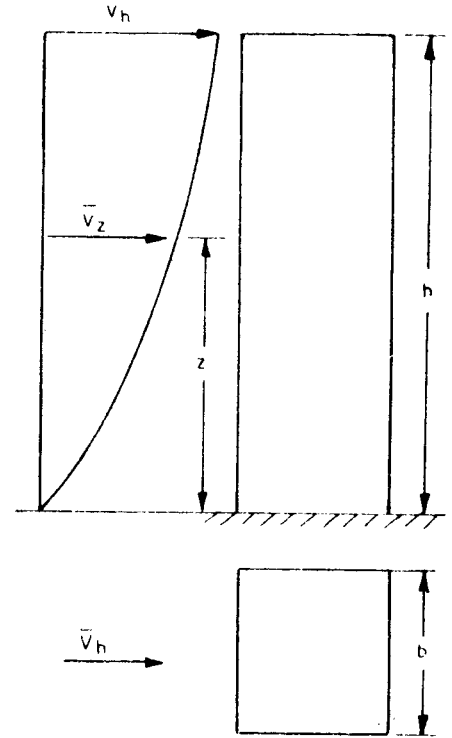
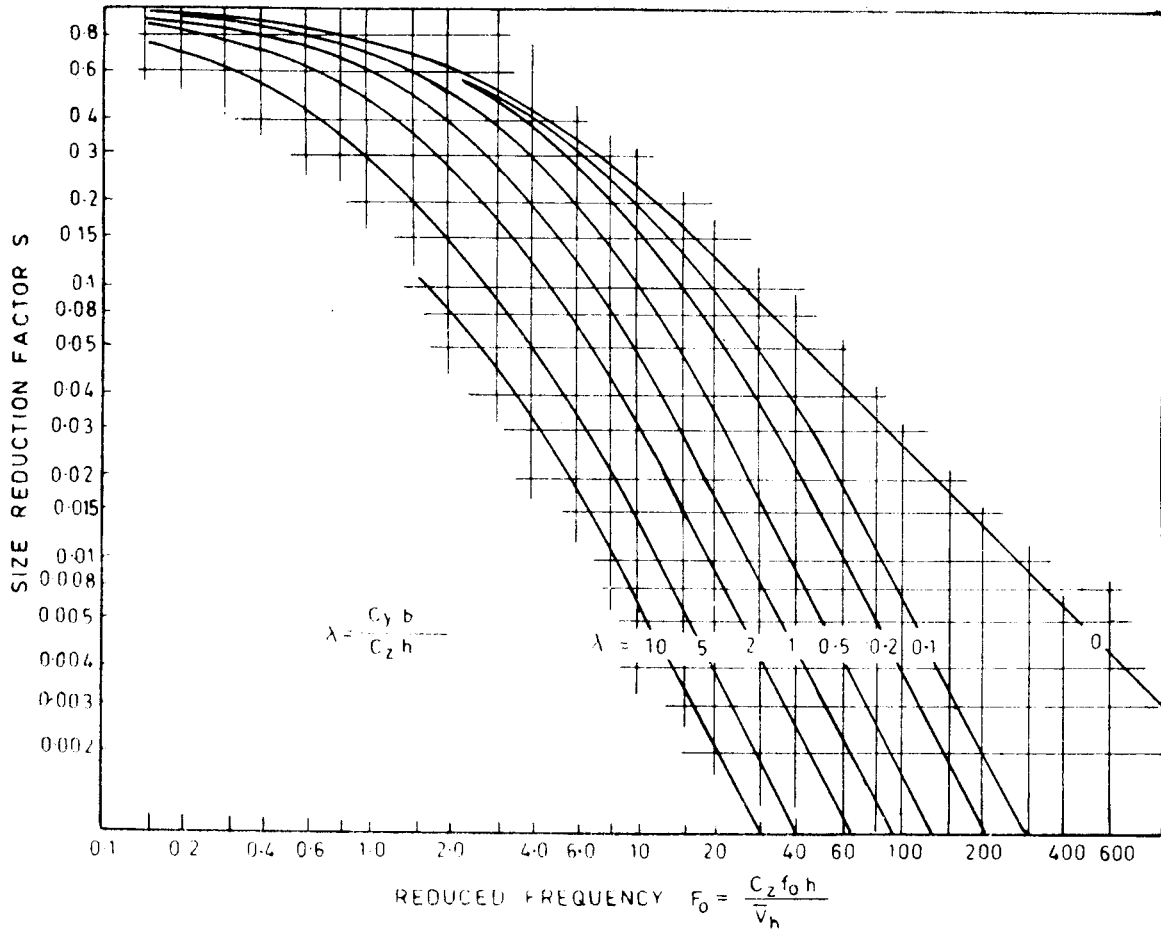

FIG. 10 SIZE REDUCTION FACTOR,  $S$

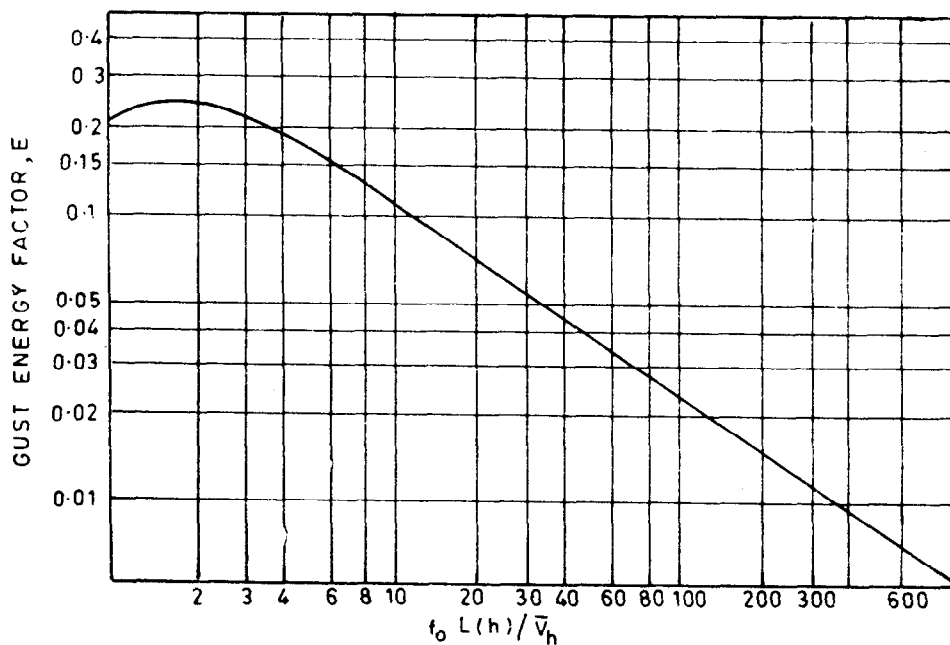

FIG. 11 GUST ENERGY FACTOR,  $E$

In figures 8 to 11,

$$\lambda = \frac{C_y b}{C_z h} \text{ and } F_o = \frac{C_z f_o h}{\bar{V}_h}$$

where

$C_y$  = lateral correlation constant which may be taken as 10 in the absence of more precise load data,

$C_z$  = longitudinal correlation constant which may be taken as 12 in the absence of more precise load data,

$b$  = breadth of a structure normal to the wind stream,

$h$  = height of a structure,

$\bar{V}_h = \bar{V}_z$  = hourly mean wind speed at height  $z$ ,

$f_o$  = natural frequency of the structure, and

$L_{(h)}$  = a measure of turbulence length scale (see Fig. 9).

TABLE 34 SUGGESTED VALUES OF DAMPING COEFFICIENT  
( Clause 8.3 )

NATURE OF STRUCTURE (1)	DAMPING COEFFICIENT, $\beta$ (2)
Welded steel structures	0.010
Bolted steel structures	0.020
Reinforced concrete structures	0.016

8.3.1 The peak acceleration along the wind direction at the top of the structure is given by the following formula:

$$a = (2 \pi f_o)^2 \bar{x} g \sqrt{\frac{SE}{\beta}}$$

where

$\bar{x}$  = mean deflection at the position where the acceleration is required.

Other notations are same as given in 8.3.

## APPENDIX A

( Clause 5.2 )

## BASIC WIND SPEED AT 10 m HEIGHT FOR SOME IMPORTANT CITIES/TOWNS

<i>City/Town</i>	<i>Basic Wind Speed ( m/s )</i>	<i>City/Town</i>	<i>Basic Wind Speed ( m/s )</i>
Agra	47	Jhansi	47
Ahmadabad	39	Jodhpur	47
Ajmer	47	Kanpur	47
Almora	47	Kohima	44
Amritsar	47	Kurnool	39
Asansol	47	Lakshadweep	39
Aurangabad	39	Lucknow	47
Bahraich	47	Ludhiana	47
Bangalore	33	Madras	50
Barauni	47	Madurai	39
Bareilly	47	Mandi	39
Bhatinda	47	Mangalore	39
Bhilai	39	Moradabad	47
Bhopal	39	Mysore	33
Bhubaneshwar	50	Nagpur	44
Bhuj	50	Nainital	47
Bikaner	47	Nasik	39
Bokaro	47	Nellore	50
Bombay	44	Panjim	39
Calcutta	50	Patiala	47
Calicut	39	Patna	47
Chandigarh	47	Pondicherry	50
Coimbatore	39	Port Blair	44
Cuttack	50	Pune	39
Darbhanga	55	Raipur	39
Darjeeling	47	Rajkot	39
Dehra Dun	47	Ranchi	39
Delhi	47	Roorkee	39
Durgapur	47	Rourkela	39
Gangtok	47	Simla	39
Gauhati	50	Srinagar	39
Gaya	39	Surat	44
Gorakhpur	47	Tiruchchirappalli	47
Hyderabad	44	Trivandrum	39
Imphal	47	Udaipur	47
Jabalpur	47	Vadodara	44
Jaipur	47	Varanasi	47
Jamshedpur	47	Vijaywada	50
		Visakhapatnam	50

**APPENDIX B**

[ Clause 5.3.2.4(b)(ii) ]

**CHANGES IN TERRAIN CATEGORIES**

**B-1. LOW TO HIGH NUMBER**

**B-1.1** In cases of transition from a low category number ( corresponding to a low terrain roughness ) to a higher category number ( corresponding to a rougher terrain ), the velocity profile over the rougher terrain shall be determined as follows:

- a) Below height  $h_x$ , the velocities shall be determined in relation to the rougher terrain; and
- b) Above height  $h_x$ , the velocities shall be determined in relation to the less rough ( more distant ) terrain.

**B-2. HIGH TO LOW NUMBER**

**B-2.1** In cases of transition from a more rough to a less rough terrain, the velocity profile shall be determined as follows:

- a) Above height  $h_x$ , the velocities shall be

determined in accordance with the rougher ( more distant ) terrain; and

- b) Below height  $h_x$ , the velocity shall be taken as the lesser of the following:
  - i) that determined in accordance with the less rough terrain, and
  - ii) the velocity at height  $h_x$  as determined in relation to the rougher terrain.

NOTE — Examples of determination of velocity profiles in the vicinity of a change in terrain category are shown in Fig. 12A and 12B.

**B-3. MORE THAN ONE CATEGORY**

**B-3.1** Terrain changes involving more than one category shall be treated in similar fashion to that described in **B-1** and **B-2**.

NOTE — Examples involving three terrain categories are shown in Fig. 12C.

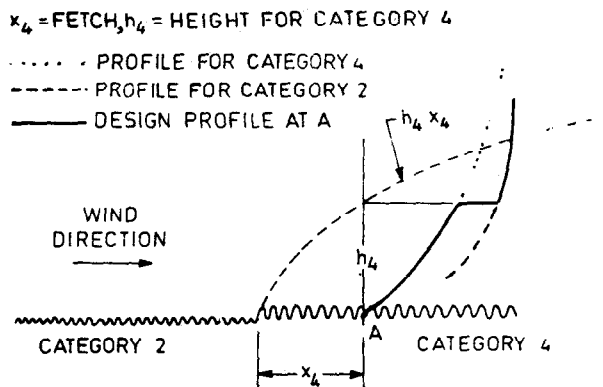

12A Determination of Velocity Profile Near a Change in Terrain Category ( less rough to more rough )

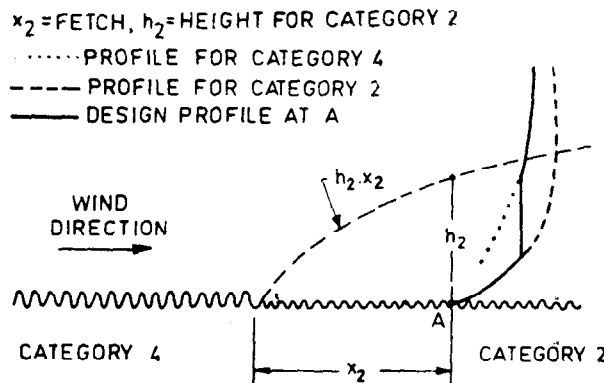

12B Determination of Velocity Profile Near a Change in Terrain Category ( more rough to less rough )

FIG. 12 VELOCITY PROFILE IN THE VICINITY OF A CHANGE IN TERRAIN CATEGORY — Contd

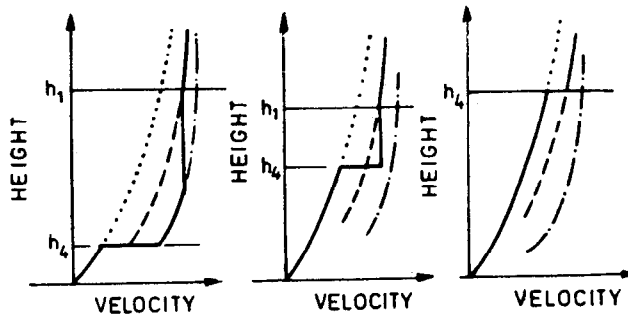
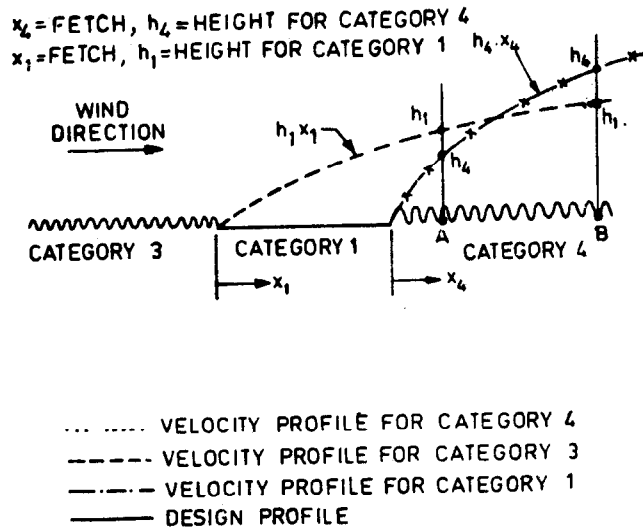

12C Determination of Design Profile Involving More Than One Change in Terrain Category  
 FIG. 12 VELOCITY PROFILE IN THE VICINITY OF A CHANGE IN TERRAIN CATEGORY

**APPENDIX C**  
 ( Clause 5.3.3.1 )

**EFFECT OF A CLIFF OR ESCARPMENT ON EQUIVALENT HEIGHT ABOVE GROUND (  $k_3$  FACTOR )**

**C-1.** The influence of the topographic feature is considered to extend  $1.5 L_0$  upwind add  $2.5 L_0$  downwind of the summit of crest of the feature where  $L_0$  is the effective horizontal length of the hill depending on slope as indicated below ( see Fig. 13 ):

Slope	$L_0$
$3^\circ < \theta \leq 17^\circ$	$L$
$> 17^\circ$	$\frac{z}{0.3}$

where

$L$  = actual length of the upwind slope in the wind direction,

$z$  = effective height of the feature, and  
 $\theta$  = upwind slope in the wind direction.

If the zone downwind from the crest of the feature is relatively flat ( $\theta < 3^\circ$ ) for a distance exceeding  $L_0$ , then the feature should be treated as an escarpment. If not, then the feature should be treated as a hill or ridge. Examples of typical features are given in Fig. 13.

NOTE 1 — No difference is made, in evaluating  $k_3$ , between a three dimensional hill and two dimensional ridge.

NOTE 2 — In undulating terrain, it is often not possible to decide whether the local topography to the site is significant in terms of wind flow. In such cases, the average value of the terrain upwind of the site for a distance of 5 km should be taken as the base level from wind to assess the height,  $z$ , and the upwind slope  $\theta$ , of the feature.



**C-2. TOPOGRAPHY FACTOR,  $k_s$**

The topography factor  $k_s$  is given by the following:

$$k_s = 1 + C s$$

where  $C$  has the following values:

Slope	$C$
$3^\circ < \theta \leq 17^\circ$	$1.2 \left( \frac{z}{L} \right)$
$> 17^\circ$	0.36

and  $s$  is a factor derived in accordance with C-2.1 appropriate to the height,  $H$  above mean ground

level and the distance,  $X$ , from the summit or crest relative to the effective length,  $L_e$ .

**C-2.1** The factor,  $s$ , should be determined from:

- a) Figure 14 for cliffs and escarpments, and
- b) Figure 15 for hills and ridges.

**NOTE** — Where the downwind slope of a hill or ridge is greater than  $3^\circ$ , there will be large regions of reduced accelerations or even shelter and it is not possible to give general design rules to cater for these circumstances. Values of  $s$  from Fig. 15 may be used as upper bound values.

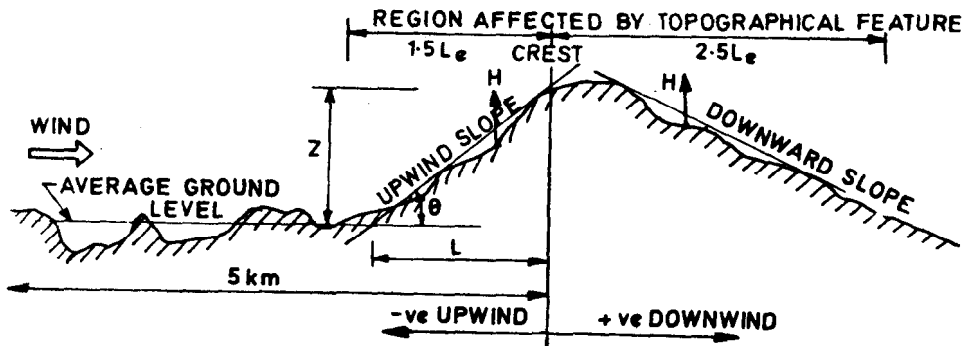

13A General Notations

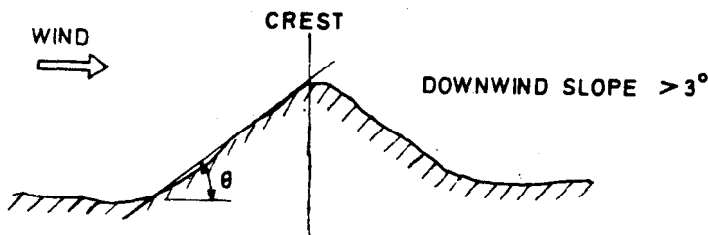

13B Cliff and Escarpment

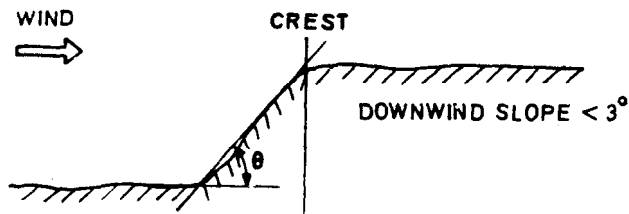

13C Hill and Ridge

FIG. 13 TOPOGRAPHICAL DIMENSIONS

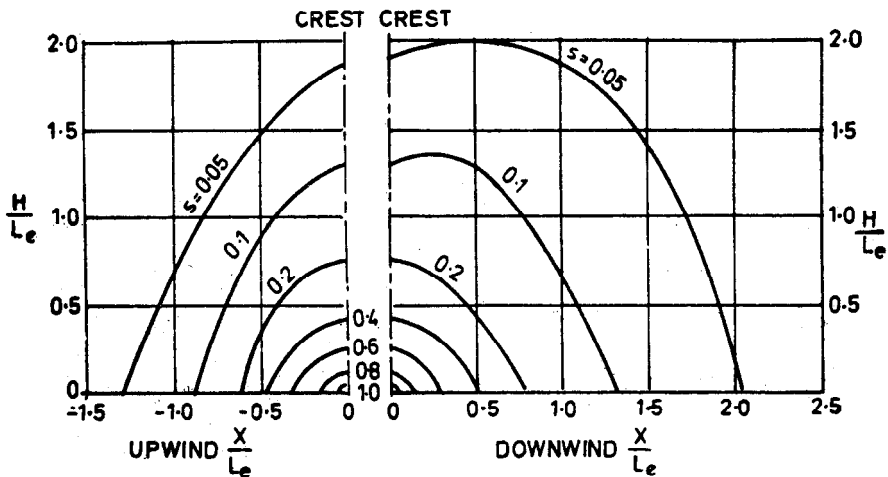

FIG. 14 FACTOR *s* FOR CLIFF AND ESCARPMENT

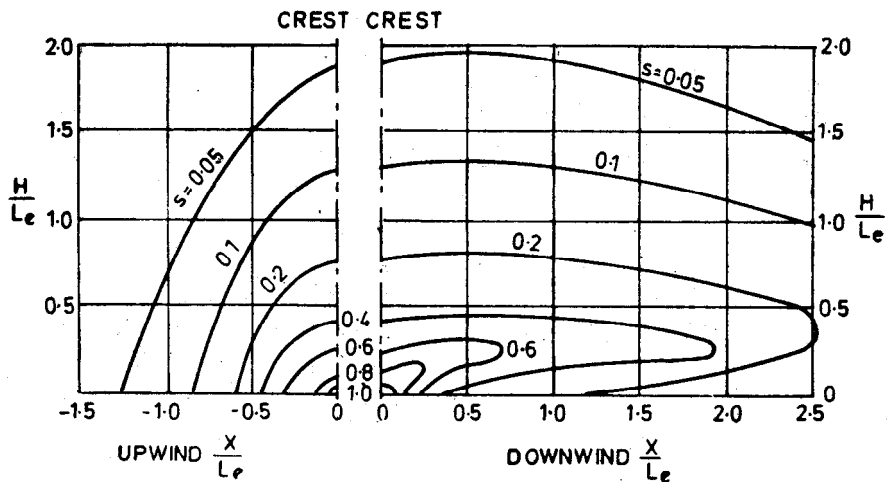

FIG. 15 FACTOR *s* FOR RIDGE AND HILL

### APPENDIX D

[ *Clauses 6.3.2.2, 6.3.3.2(c) and 6.3.3.3(b)* ]

#### WIND FORCE ON CIRCULAR SECTIONS

**D-1.** The wind force on any object is given by:

$$F = C_f A_o p_a$$

where

$C_f$  = force coefficient,

$A_o$  = effective area of the object normal to the wind direction, and

$p_a$  = design pressure of the wind.

For most shapes, the force coefficient remains approximately constant over the whole range of

wind speeds likely to be encountered. However, for objects of circular cross-section, it varies considerably.

For a circular section, the force coefficient depends upon the way in which the wind flows around it and is dependent upon the velocity and kinematic viscosity of the wind and diameter of the section. The force coefficient is usually quoted against a non-dimensional parameter, called the Reynolds number, which takes account of the

velocity and viscosity of the flowing medium ( in this case the wind ), and the member diameter.

$$\text{Reynolds number, } R_o = \frac{DV_d}{\gamma}$$

where

$D$  = diameter of the member,

$V_d$  = design wind speed, and

$\gamma$  = kinematic viscosity of the air which is  $1.46 \times 10^{-5} \text{ m}^2 \text{ s}$  at  $15^\circ\text{C}$  and standard atmospheric pressure.

Since in most natural environments likely to be found in India, the kinematic viscosity of the air is fairly constant, it is convenient to use  $DV_d$  as the parameter instead of Reynolds numbers and this has been done in this code.

The dependence of a circular section's force coefficient or Reynolds number is due to the change in the wake developed behind the body.

At a low Reynolds number, the wake is as shown in Fig. 16 and the force coefficient is typically 1.2. As Reynolds number is increased, the wake gradually changes to that shown in Fig. 17, that is, the wake width  $d_w$  decreases and the separation point,  $S$ , moves from front to the back of the body.

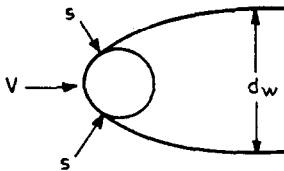

FIG. 16 WAKE IN SUBCRITICAL FLOW

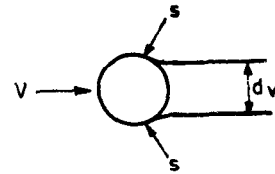

FIG. 17 WAKE IN SUPERCRITICAL FLOW

As a result, the force coefficient shows a rapid drop at a critical value of Reynolds number, followed by a gradual rise as Reynolds number is increased still further.

The variation of  $C_f$  with parameter  $DV_d$  is shown in Fig. 5 for infinitely long circular cylinders having various values of relative surface roughness ( $\epsilon/D$ ) when subjected to wind having an intensity and scale of turbulence typical of built-up urban areas. The curve for a smooth cylinder ( $\epsilon/D$ ) =  $1 \times 10^{-5}$  in a steady air-stream, as found in a low-turbulence wind tunnel, is shown for comparison.

It can be seen that the main effect of free-stream turbulence is to decrease the critical value of the parameter  $DV_d$ . For subcritical flows, turbulence can produce a considerable reduction in  $C_f$  below the steady air-stream values. For supercritical flows, this effect becomes significantly smaller.

If the surface of the cylinder is deliberately roughened such as by incorporating flutes, rivetted construction, etc, then the data given in Fig. 5 for appropriate value of  $\epsilon/D > 0$  shall be used.

NOTE — In case of uncertainty regarding the value of  $\epsilon$  to be used for small roughnesses,  $\epsilon/D$  shall be taken as 0.001.

## Bureau of Indian Standards

BIS is a statutory institution established under the *Bureau of Indian Standards Act, 1986* to promote harmonious development of the activities of standardization, marking and quality certification of goods and attending to connected matters in the country.

### Copyright

BIS has the copyright of all its publications. No part of these publications may be reproduced in any form without the prior permission in writing of BIS. This does not preclude the free use, in the course of implementing the standard, of necessary details, such as symbols and sizes, type or grade designations. Enquiries relating to copyright be addressed to the Director (Publication), BIS.

### Review of Indian Standards

Amendments are issued to standards as the need arises on the basis of comments. Standards are also reviewed periodically; a standard along with amendments is reaffirmed when such review indicates that no changes are needed; if the review indicates that changes are needed, it is taken up for revision. Users of Indian Standards should ascertain that they are in possession of the latest amendments or edition by referring to the latest issue of 'BIS Handbook' and 'Standards Monthly Additions'

### Amendments Issued Since Publication

Amend No.	Date of Issue	Text Affected

### BUREAU OF INDIAN STANDARDS

#### Headquarters:

Manak Bhavan, 9 Bahadur Shah Zafar Marg, New Delhi 110002  
Telephones: 323 01 31, 323 33 75, 323 94 02

Telegrams: Manaksanstha  
(Common to all offices)

#### Regional Offices:

Central : Manak Bhavan, 9 Bahadur Shah Zafar Marg  
NEW DELHI 110002

Telephone  
323 76 17, 323 38 41

Eastern : 1/14 C.I.T. Scheme VII M, V.I.P. Road, Maniktola  
CALCUTTA 700054

{ 337 84 99, 337 85 61  
{ 337 86 26, 337 91 20

Northern : SCO 335-336, Sector 34-A, CHANDIGARH 160022

{ 60 38 43  
{ 60 20 25

Southern : C.I.T. Campus, IV Cross Road, CHENNAI 600113

{ 235 02 16, 235 04 42  
{ 235 15 19, 235 23 15

Western : Manakalaya, E9 MIDC, Marol, Andheri (East)  
MUMBAI 400093

{ 832 92 95, 832 78 58  
{ 832 78 91, 832 78 92

Branches : AHMADABAD. BANGALORE. BHOPAL. BHUBANESHWAR.  
COIMBATORE. FARIDABAD. GHAZIABAD. GUWAHATI.  
HYDERABAD. JAIPUR. KANPUR. LUCKNOW. NAGPUR.  
PATNA. PUNE. THIRUVANANTHAPURAM.

AMENDMENT NO. 1 DECEMBER 1997  
TO  
IS 875 ( Part 3 ) : 1987 CODE OF PRACTICE FOR  
DESIGN LOADS (OTHER THAN EARTHQUAKE) FOR  
BUILDINGS AND STRUCTURES

PART 3 WIND LOADS

( *Second Revision* )

( Page 15, Table 4, first column ) — Substitute

$$\frac{h}{w} \geq 6 \text{ for } \frac{h}{w} \geq \infty$$

( Page 40, Table 23, first column, first row ) — Substitute '*See also Appendix D*' for '*See also Appendix C*'.

( Page 47, Table 32, col 2 ) — Substitute

$$'DV_d \geq 6 \text{ m}^2/\text{s}' \text{ for } 'DV_d \leq 6 \text{ m}^2/\text{s}'.$$

( CED 37 )

**AMENDMENT NO. 2 MARCH 2002**  
**TO**  
**IS 875 (PART 3) : 1987 CODE OF PRACTICE FOR**  
**DESIGN LOADS (OTHER THAN EARTHQUAKE) FOR**  
**BUILDINGS AND STRUCTURES**

**PART 3 WIND LOADS**

*( Second Revision )*

Substitute 'Vz' for 'Vd' at all places.

( Tables 5, 6, 7 and 8 ) — Insert the following Note at the end of each table:

NOTE — *W* and *L* are overall length and width including overhangs, *w* and *l* are dimensions between the walls excluding overhangs.

( Tables 9, 10, 11, 12, 13 and 14, first column ) — Substitute the following matter in the last row for the specific values of  $\theta$  given therein:

'for all values of  $\theta$ '

[ Page 27, clause 6.2.2.7(a) ] — Insert at the end 'downwards'.

[ Page 27, clause 6.2.2.8(a) ] — Substitute '-0.8' for '0.8'.

[ Page 27, clause 6.2.2.8(b) ] — Substitute '-0.5' for '0.5'.

( Page 27, clause 6.2.2.9 ) — Substitute ' $P = 0.785 D^2 (C_{pi} - C_{pe}) p_d$ ' for the existing formula.

( Page 32, Table 19 ) — Substitute ' $P = 0.785 D^2 (C_{pi} - C_{pe}) p_d$ ' for the existing formula.

( Page 46, Table 27, third row ) — Substitute ' $D V_d < 6 \text{ m}^2/\text{s}$ ' for the existing.

( Page 46, Table 28, col 2, second row ) — Substitute '1.8' for '1.0'.

( Page 46, clause 6.3.3.3, formula, last line ) — Substitute

$$\gamma = \frac{\text{( Area of the frame in a supercritical flow )}}{A_e} \quad \text{for the existing.}$$

[ Page 47, clause 7.1(a), third line ] — Substitute 'or' for 'and'.

[ Page 48, clause 7.1(b), first line ] — Delete 'closed'.

( Page 48, clause 7.1, fourth and fifth line ) — Substitute 'satisfies' for 'does not satisfy'.

( Page 55, clause C-1, second line ) — Substitute 'and' for 'add'.

( Page 56, clause C-2, last line ) — Insert ',' between 'crest' and 'relative'.

( Page 56, Fig. 13A ) — Substitute the following figure for the existing:

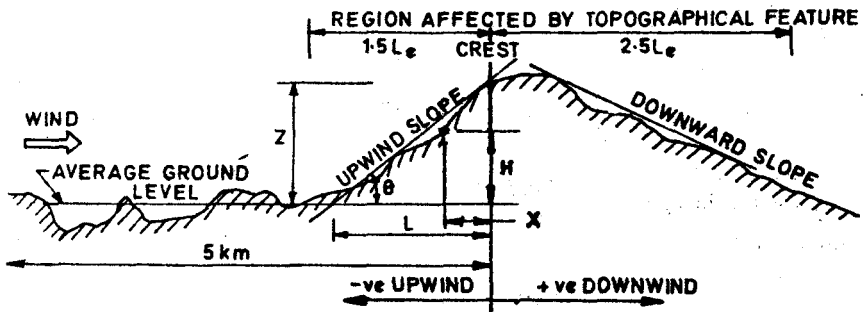

13A General Notations

( Page 56, Fig. 13B ) — Substitute 'Hill and Ridge' for 'Cliff and Escarpment'.

( Page 56, Fig. 13C ) — Substitute 'Cliff and Escarpment' for 'Hill and Ridge'.

( Page 58, clause D-1, eighth line ) — Substitute ' $m^2/s$ ' for ' $m^2s$ '.

( CED 57 )